



FAI Sporting Code

*Fédération
Aéronautique
Internationale*

Section 4 – Aeromodelling

Volume F3 Radio Control Model Helicopters

2018 Edition

Effective 1st January 2018

F3C – RC AEROBATIC HELICOPTERS
F3N – RC FREESTYLE AEROBATIC HELICOPTERS
ANNEX 5D – F3C MANOEUVRE DESCRIPTIONS & DIAGRAMS
ANNEX 5E – F3C JUDGES' GUIDE
ANNEX 5F – F3N MANOEUVRE DESCRIPTIONS & DIAGRAMS
ANNEX 5G – F3N JUDGES' GUIDE
ANNEX 5H – RADIO CONTROL MODEL HELICOPTERS WORLD
CUP RULES

*Maison du Sport International
Avenue de Rhodanie 54
CH-1007 Lausanne
Switzerland
Tel: +41(0)21/345.10.70
Fax: +41(0)21/345.10.77
Email: sec@fai.org
Web: www.fai.org*

FEDERATION AERONAUTIQUE INTERNATIONALE
MSI - Avenue de Rhodanie 54 – CH-1007 Lausanne – Switzerland

Copyright 2018

All rights reserved. Copyright in this document is owned by the Fédération Aéronautique Internationale (FAI). Any person acting on behalf of the FAI or one of its Members is hereby authorised to copy, print, and distribute this document, subject to the following conditions:

- 1. The document may be used for information only and may not be exploited for commercial purposes.**
- 2. Any copy of this document or portion thereof must include this copyright notice.**
- 3. Regulations applicable to air law, air traffic and control in the respective countries are reserved in any event. They must be observed and, where applicable, take precedence over any sport regulations.**

Note that any product, process or technology described in the document may be the subject of other Intellectual Property rights reserved by the Fédération Aéronautique Internationale or other entities and is not licensed hereunder.

RIGHTS TO FAI INTERNATIONAL SPORTING EVENTS

All international sporting events organised wholly or partly under the rules of the Fédération Aéronautique Internationale (FAI) Sporting Code¹ are termed *FAI International Sporting Events*². Under the FAI Statutes³, FAI owns and controls all rights relating to FAI International Sporting Events. FAI Members⁴ shall, within their national territories⁵, enforce FAI ownership of FAI International Sporting Events and require them to be registered in the FAI Sporting Calendar⁶.

An event organiser who wishes to exploit rights to any commercial activity at such events shall seek prior agreement with FAI. The rights owned by FAI which may, by agreement, be transferred to event organisers include, but are not limited to advertising at or for FAI events, use of the event name or logo for merchandising purposes and use of any sound, image, program and/or data, whether recorded electronically or otherwise or transmitted in real time. This includes specifically all rights to the use of any material, electronic or other, including software that forms part of any method or system for judging, scoring, performance evaluation or information utilised in any FAI International Sporting Event⁷.

Each FAI Air Sport Commission⁸ may negotiate agreements, with FAI Members or other entities authorised by the appropriate FAI Member, for the transfer of all or parts of the rights to any FAI International Sporting Event (except World Air Games events⁹) in the discipline¹⁰, for which it is responsible¹¹ or waive the rights. Any such agreement or waiver, after approval by the appropriate Air Sport Commission President, shall be signed by FAI Officers¹².

Any person or legal entity that accepts responsibility for organising an FAI Sporting Event, whether or not by written agreement, in doing so also accepts the proprietary rights of FAI as stated above. Where no transfer of rights has been agreed in writing, FAI shall retain all rights to the event. Regardless of any agreement or transfer of rights, FAI shall have, free of charge for its own archival and/or promotional use, full access to any sound and/or visual images of any FAI Sporting Event. The FAI also reserves the right to arrange at its own expense for any and all parts of any event to be recorded.

-
- 1 FAI Statutes, Chapter 1, para. 1.6
 - 2 FAI Sporting Code, Gen. Section, Chapter 4, para 4.1.2
 - 3 FAI Statutes, Chapter 1, para 1.8.1
 - 4 FAI Statutes, Chapter 2, para 2.1.1; 2.4.2; 2.5.2 and 2.7.2
 - 5 FAI By-Laws, Chapter 1, para 1.2.1
 - 6 FAI Statutes, Chapter 2, para 2.4.2.2.5
 - 7 FAI By-Laws, Chapter 1, paras 1.2.2 to 1.2.5
 - 8 FAI Statutes, Chapter 5, paras 5.1.1, 5.2, 5.2.3 and 5.2.3.3
 - 9 FAI Sporting Code, Gen. Section, Chapter 4, para 4.1.5
 - 10 FAI Sporting Code, Gen. Section, Chapter 2, para 2.2.
 - 11 FAI Statutes, Chapter 5, para 5.2.3.3.7
 - 12 FAI Statutes, Chapter 6, para 6.1.2.1.3

PAGE DELIBERATELY LEFT BLANK

VOLUME F3 HELICOPTERS

SECTION 4C – MODEL AIRCRAFT – F3 HELICOPTERS

Part Five – Technical Regulations for Radio Controlled Contests

5.4. F3C RC Aerobatic Helicopters

Annex 5D – F3C Manoeuvre Description & Diagrams

Annex 5E – F3C Judges' Guide

5.11 F3N RC Freestyle Aerobatic Helicopters

Annex 5F – F3N Manoeuvre Description & Diagrams

Annex 5G – F3N Judges' Guide

Annex 5H – Radio Control Model Helicopters World Cup Rules

THIS 2018 EDITION INCLUDES THE FOLLOWING AMENDMENTS MADE TO 2017 CODE

These amendments are marked by a double line in the right margin of this edition

Paragraph	Plenary meeting approving change	Brief description of change	Change incorporated by
F3C	2017		Kevin Dodd Technical Secretary & Stefan Wolf, F3 Helicopter S-C Chairman
5.4.A		Addition of 2 flags to mark the 120 degree window in contest area.	
F3N			
5.11.6.		Same start/finish signal for all programs.	
5.11.9.		Clarification to unify preparation time.	
Annexes			
5D.2.		Clarification. Slight addition to judging criteria to align with schedule.	
5E.6.11.		Autorotations. Entire section rewritten for clarification.	
5F		New set manoeuvres.	
5F.1.28		Effective 01/06/17. <i>Duus Igloo</i> rewritten due to safety.	
5G.8.		Effective 01/06/17. Further clarification to criteria for judging freestyle and music freestyle points table.	
5G.8.1.		Effective 01/06/17. Clarification.	
5F.3	n/a	Class F3N Optional Manoeuvre List is set annually.	

Four-Year Rolling Amendments for Reference

Paragraph	Plenary meeting approving change	Brief description of change	Change incorporated by
Contents & subsequent references	2016	Minor changes in the names of F3C and F3N in line with 2017 CIAM Classes document.	Kevin Dodd Technical Secretary & Dag Eckoff, F3 Helicopter S-C Chairman
Throughout		Upgrade previous cross references to ABR to the corresponding paragraph in CIAM General Rules.	
5.4.2.		Change to refer to CIAM General Rules (C.5.1.2) - does not now require competitor to build model.	
5.4.11. & 5.11.8.		Team Classification method quoted from CIAM General Rules C.15.6.2 (clarification).	
Annex 5E		F3C Judges' Guide	
5E.6.11.		Effective 01/05/16. Autorotations. Entire section rewritten for clarification.	
Annex 5G		F3N Judges' Guide	
5G.6.7.		Effective 01/05/16. New text added to differentiate between a pushed flip and pulled flip.	
5G.8.6.		Effective 01/05/16. Level of difficulty for freestyle schedule table replaced.	
5G.8.		Effective 01/05/16. Criteria for judging freestyle and music freestyle points table amended. K-Factors amended for music freestyle.	
Annex 5H		World Cup Rules	
5H.10.		Appropriate form of CIAM General Rules C.7.4 used for definition of World Cup Board.	
Annex 5F 5F.3	n/a	Class F3N Optional Manoeuvre List is set annually.	

cont/...

Four-Year Rolling Amendments for Reference			
Paragraph	Plenary meeting approving change	Brief description of change	Change incorporated by
F3C	2015		Kevin Dodd Technical Secretary on behalf of Dag Eckoff, F3 Helicopter S-C Chairman
5.4.11		Points should be rounded to two decimal places.	
Annex 5D		New schedules for F3C	
Annex 5H		New annex to incorporate World Cup for F3C and F3N	
F3N			
5.11.3		Amend paragraph and diagram to include centre line for safety.	
5.11.7		'Not Observed' mark to be averaged to nearest whole point.	
5.11.8		Include new paragraph to define classification for F3N	
5.11.8		Points should be rounded to two decimal places.	
5.11.10		Changed penalty applied to MA tilting over.	
Annex 5F 1.2		Changed K-Factor for Inverted pirouette.	
Annex 5F 1.8		Clarified description of Inverted horizontal eight.	
Annex 5F 1.25		Changed K-Factor and description of Double 4-point Tic-toc	
Annex 5F 1.28		Replaced Square of Rainbows with Duus Igglo	
Annex 5F 1.29		Replaced Four-way pirouetting tic-toc with Pirorainbow X reversal	
Annex 5G.8		Amended Judges Guide for Freestyle and Music Freestyle with more direction for awarding points.	
Annex 5G.8.2		Extended directions for judging Harmony in Freestyle.	
Annex 5H		New annex to incorporate World Cup for F3C and F3N	
Annex 5H.10		Consequential change for ABR Section 4B Para. B.18.1. : increase protest fee from 35 to 50 Euro.	
Annex 5F 5F.3	n/a	Class F3N Optional Manoeuvre List is set annually.	

Four-Year Rolling Amendments for Reference			
Paragraph	Plenary meeting approving change	Brief description of change	Change incorporated by
5G.8.1	2014	Add text for safety reasons to penalise risky manoeuvres in freestyle flight.	Kevin Dodd Technical Secretary
Annex 5F 5F.3	n/a	Class F3N Optional Manoeuvre List is set annually.	

Four-Year Rolling Amendments for Reference			
Paragraph	Plenary meeting approving change	Brief description of change	Change incorporated by
F3C 5.4.14	2013	Corrected the schedule's valid years to 2015 - 2015	Jo Halman, Technical Secretary
Annex 5D		Corrected manoeuvre names for F.6 & F.7	
F3C	n/a		Jo Halman, Technical Secretary on behalf of Dag Eckoff, F3 Helicopter S-C Chairman
Annex 5D			
5D.1		Relocated both instances of the landing scoring reference from the end of the P & F schedules to the end of this paragraph.	
5D.2 - P2		Corrected flag numbers.	
5D.2 - P4		Clarified regarding altitude	
5D.2 - P5		Clarified note.	
5D.2 - P8		Corrected the manoeuvre title to match the manoeuvre description; clarified note.	
5D.2 - P9		Added missing text.	
5D.3 - F2 & F3		Clarified note.	
5D.3 - F4		Added missing word.	

5D.3 - F5		Corrected the manoeuvre title to match the manoeuvre description; clarified note.	
5D.3 - F6		Corrected the manoeuvre title to match the manoeuvre description.	
5D.3 - F7		Added missing word.	
F3C Annex 5E		Added new "9 – Stall Turns" to bring in line with new manoeuvre descriptions & re-numbered the two subsequent paragraphs.	
F3C			
5.4.3 d)		Replaced the existing paragraph entirely.	
5.4.10		Added a new paragraph e).	
Annex 5D		First paragraph: reduced the flight time to 9 minutes & added new schedules P & F list of manoeuvres.	
5D.2		Added the Schedule P manoeuvre descriptions & diagrams.	
5D.3		Added the Schedule F manoeuvre descriptions & diagrams.	
F3N			
5.11.6	2013	Deleted the restriction on restarting the engine.	
5.11.7		Added a new final paragraph regarding visibility of manoeuvres.	
5.11.9		Clarified when the flight time begins.	
Annex 5F			
5F.1		Deleted the downgrade if the engine is running during auto-rotation.	
1.15; 1.24; 1.29; 1.30.		Replaced manoeuvres. See the new diagrams.	
1.22; 1.23; 1.26; 1.28		Changed the K-factors.	

RULE FREEZE FOR THIS VOLUME

With reference to paragraph A.10.2 of CIAM General Rules:

In all classes, the two-year rule for no changes to model aircraft/space model specifications, manoeuvre schedules and competition rules will be strictly enforced. For Championship classes, changes may be proposed in the year of the World Championship of each category.

For official classes without Championship status, the two-year cycle begins in the year that the Plenary Meeting approved the official status of the class. For official classes, changes may be proposed in the second year of the two-year cycle.

This means that in Volume F3 Helicopters:

- (a) changes for F3C and F3N can next be agreed at the Plenary meeting 2019 for application from January 2020; note that F3N optional manoeuvres are set annually and approved by CIAM Bureau.
- (b) provisional classes are not subject to this restriction.

The only exceptions allowed to the two-year rule freeze are genuine and urgent safety matters, indispensable rule clarifications and noise rulings.

VOLUME F3 HELICOPTERS

PART FIVE - TECHNICAL REGULATIONS FOR RADIO CONTROLLED CONTESTS

5.4. CLASS F3C – RC AEROBATIC HELICOPTERS

5.4.1. Definition of a Radio Controlled (R/C) Helicopter

An R/C helicopter is a heavier-than-air model aircraft (MA) that derives all of its lift and horizontal propulsion from a power driven rotor system(s) rotating about a nominally vertical axis (or axes). Fixed horizontal supporting surfaces up to 4% of the swept area of the lifting rotor(s) are permitted. A fixed or controllable horizontal stabiliser of up to 2% of the swept area of the lifting rotor(s) is permitted. Ground effect machines (hovercraft), convertiplanes or aircraft that hover by means of propeller slipstream(s) deflected downward are not considered to be helicopters.

5.4.2. Builder of the Model Aircraft

There is no requirement for the competitor to be the builder of the model in F3C. Refer C.5.1.2. in *CIAM General Rules*.

5.4.3. General Characteristics

- a) AREA: The swept area of the lifting rotor cannot exceed 250dm². For helicopters with multiple rotors whose rotor shafts are more than one rotor diameter apart the total swept area of both rotors cannot exceed 250dm². For helicopters with multiple rotors whose rotor shafts are less than one rotor diameter apart the swept area of both rotors (counting the area of superposition only once) cannot exceed 250dm². The tail rotor must be driven by the main rotor and must not be driven by a separate engine/motor.
- b) WEIGHT: The weight of the model aircraft (with fuel / with batteries) must not exceed 6.5 kg.
- c) MOTOR: Internal combustion engine displacement: no restrictions.
Electric motors are limited to a maximum no load voltage of 51 volts for the propulsion circuit.
- d) GYROS: The use of pre-programmed flight manoeuvres is forbidden. The use of automatic position (latitude and longitude) locking devices and altitude locking devices, whether with external references or not, are forbidden.
- e) ROTOR BLADES: All-metal main or tail rotor blades are prohibited.

5.4.4. Noise Limit

Noise level measurements must be made before the start of a competition, preferably during the official practice day. The noise level must be measured at a distance of 3m (3 metres) while the helicopter is hovering with the skids/landing gear at 2m over the centre of a 2m diameter circle. A remote microphone mounted on a tripod must be used. The engine speed (RPM) must be the same as that used during the hovering portion of the flight schedules. During the measurement the helicopter must be rotated through 360° to determine the maximum noise level. The sound pressure level must not exceed 87dB (A) over a soft (grass) surface or 89dB (A) over a hard (asphalt, concrete, etc) surface. If the noise level limit is exceeded during the first measurement, two additional measurements must be made to substantiate the excessive noise level. The competitor may modify the helicopter and/or silencer system to reduce the noise level and after verification of an acceptable level, will be permitted to fly. If the noise level cannot be reduced to or below the noise level limit it will not be allowed to fly in the competition. The measuring equipment must be calibrated to the dB (A) sound pressure level scale defined in applicable ISO Standards. If noise measuring equipment that can be calibrated to ISO Standards is not available, the measurements will be advisory only and no competitor can be excluded from the competition.

5.4.5. Contest Area Layout

See FIGURE 5.4.A. Note: If two flight lines are used they must be parallel, operate simultaneously, face in the same direction and be separated by a minimum of 500m for a “front-to-back configuration” or a minimum of 1000m for a side-by-side configuration.

5.4.6. Number of Helpers

Each competitor is allowed only one mechanic/caller. The mechanic/caller must announce the start, finish and name or number of each manoeuvre, and should inform the pilot of wind direction, remaining flight time, proximity to prohibited areas and intrusions into the flight area.

Team managers may observe the flight from a position 5m behind the judges and away from the start circle. Team managers may serve as mechanic/caller if no separate person is available for this task.

5.4.7. Number of Model Aircraft

The number of model aircraft eligible for entry is two (2). Model aircraft numbers 1 and 2 may only be exchanged within the start circle. Both model aircraft must use the same radio frequency.

5.4.8. Number of Flights

At Continental and World Championships, each competitor is entitled to four (4) official preliminary flights. After completion of the preliminary flights the top 15 are entitled to three fly-off flights. At national and Open International Competitions the preliminary/fly-off system is not mandatory.

5.4.9. Definition of an Official Flight

There is an official flight when the competitor is officially called. The flight may be repeated if, for any unforeseen reason outside the control of the competitor, the model aircraft fails to make a start such as:

- a) The flight cannot safely be made within the allowed time limit.
- b) The competitor can prove that the flight was hindered by outside interference.
- c) Judging was impossible for reasons beyond the control of the competitor (model aircraft, engine, or radio failures are not considered to be outside the control of the competitor). In such cases the flight **shall** be repeated as close to the published time as possible. The competitor, however, has the right to refuse a reflight.

5.4.10. Scoring

Each manoeuvre is given a score between 0 and 10 (including half) points by each judge. A new score sheet is issued to each competitor for each round. Only the competitor's number (no name or nationality) will appear on the score sheet. Any manoeuvre not completed shall be scored zero (0) points. If a manoeuvre is scored zero points all judges must agree. There shall be an official located on the field where any flight over the prohibited area can be observed. The prohibited area is the shaded area in Figure 5.4.A behind the judges' line. The area extends to infinity to the left, right and rear. A visual or audible signal shall be given to indicate such over flights. Competitors flying over this area will be penalised by scoring zero (0) points for the current flight. However, the judges shall score all manoeuvres. If an infringement has been made, the scores will be deleted from all score sheets after the flight. In addition, there shall be no score when:

- a) The competitor flies a model aircraft that has been flown in the same competition by another competitor, or flies a model aircraft that does not comply with the definition and general characteristics of a radio controlled helicopter.
- b) The competitor does not deliver his transmitter to the impound or operates any transmitter at the competition area during a round without permission.
- c) The competitor starts his model aircraft outside of the start circle.
- d) The competitor gets his transmitter from the impound before he is officially called.
- e) Manoeuvres must be performed where they can be seen clearly by the judges. If a judge, for some reason beyond the control of the competitor, is not able to follow the model aircraft through the entire manoeuvre, he may put a "Not Observed" (N.O.) mark. In this case, his score will, for that particular manoeuvre, be set to the average score given by the other judges, rounded to the nearest half point.

5.4.11. Classification

After the completion of four official (preliminary) rounds, the best three scores will be used to determine the placings. The top 15 of all competitors then compete in three fly-off rounds to determine the final individual classification. The results of the best three preliminary rounds (normalised to 1000 points) will count as one score. This score, plus the three fly-off scores, provide four scores with the best three to count for the final individual classification. The fly-offs to determine the individual classification are only required for World and Continental Championships.

If the competition is interrupted during the preliminary rounds, the final individual classification will be determined by counting all completed preliminary rounds and dropping the lowest. If the competition is interrupted during the fly-off rounds, the final individual classification will be determined by counting all completed fly-off rounds plus the results from the preliminary rounds and dropping the lowest.

All scores for each round will be normalised by awarding 1000 points to the highest scoring flight. The remaining scores are then normalised to a percentage of the 1000 points in the ratio of actual score over the score of the winner of the round. If only one round is possible then the classification will be based on that one round.

For example:

$\text{Points}_{(x)} = \text{Score}_{(x)} \text{ divided by } \text{Score}_{(w)} \text{ multiplied by } 1000$

Where $\text{Points}_{(x)} = \text{Points awarded to competitor X}$

$\text{Score}_{(x)} = \text{Score of competitor X}$

$\text{Score}_{(w)} = \text{Score of winner of the round}$

Points (x) should be calculated to at least two decimal places and recorded (truncated) to two places after decimal point.

Ties for any of the first three places will be broken by counting the highest throwaway score. If the tie still stands a "sudden death" fly-off must take place within one hour of the end of the scheduled fly-off rounds.

The team classification for World and Continental Championships is established at the end of the competition (after the fly-off flights) by adding together the numerical final placings of the three team members using the full list of competitors unless there is a fourth member of the team (who must always be a junior) in which case it will be the three best placed members. Teams are ranked from the lowest numerical scores to the highest, with complete three-competitor teams ahead of two-competitor teams, which in turn are ranked ahead of one-competitor teams. In case of a tie, the best individual placing decides the team ranking. (Ref: *CIAM General Rules*, C.15.6.2 i))

5.4.12. Judging

At Continental and World Championships the organiser must appoint a panel of five judges for each round/flight line. When the entry exceeds 55, two flight lines must be used. The judges must be of different nationalities and must be selected from the current CIAM list of international judges. When using two separate panels, the organiser is allowed to use two judges of the same nationality, one on each panel. Those selected must reflect the approximate geographical distribution of teams participating in the previous World Championship with the final list approval by the CIAM Bureau. At least 20% but not more than 40% of the judges must not have judged at the previous World Championships.

For the preliminary rounds the final score of each flight is obtained by deleting the highest and lowest scores for each manoeuvre from the five judges. For the fly-off rounds ten judges shall be used while dropping the two lowest and two highest scores for each manoeuvre. At open or other International Competitions the number of judges may be reduced to a minimum of three with no throwaway scores.

- a) There shall be training flights for judges with a debriefing session immediately before a Continental or World Championships.
- b) The scoring system must be organised in such a way that the competitors and the spectators can clearly see the scores awarded by all judges after each flight. The score sheet notation must be written by the judges themselves.

5.4.13. Organisation

TRANSMITTER & FREQUENCY CONTROL (See Volume *CIAM General Rules*, Section C, Paragraph C.16.2). When all transmitters are of the spread spectrum type a transmitter impound is not required.

FLIGHT ORDER

The flight order for the first preliminary round will be determined by a random draw, taking into account that frequency will not follow frequency and team member will not follow team member of the same team. The flight order for preliminary rounds two, three and four will start at the first, second and third quarter of the initial order. The flight order for the first fly-off round will be established by a random draw. The flight order for the second and third fly-off rounds will start at the first and second third of the initial order.

PREPARATION TIME

A competitor must be called at least 5 minutes before he is required to enter the start circle. A start circle 2m in diameter will be provided away from the flight line, spectators, competitors and model aircraft (see FIGURE 5.4.A). When the previous competitor's flight time reaches 6 minutes the flight line director can give the signal to start the engine. In the case of electric motors, the battery must not be connected before signal has been given. The competitor is given 5 minutes to start the engine and make last minute adjustments. The model aircraft may only be hovered in the start circle

up to 2m and must not be rotated beyond 180° left or right relative to the competitor. If the model aircraft is rotated beyond 180° the flight is terminated. The competitor in the start circle must reduce his engine's speed to an idle when the preceding competitor has completed the eighth manoeuvre. If the competitor is not ready after the 5 minute preparation time, he is allowed to complete his adjustments in the start circle; however, his flight time will have started at the end of the 5 minute interval.

FLIGHT TIME

The flight time of 9 minutes begins when the competitor's model leaves the start circle with the permission of the flight line director and the judges. If the allotted time expires before a manoeuvre is completed, that manoeuvre and all remaining manoeuvre(s) will be scored zero.

RESTRICTIONS

After starting the model aircraft in the start circle the model aircraft must be flown at 2m to the helipad along the model entry path shown on the Contest Area Layout (Figure 5.4.A). The pilot may test hover the helicopter on the helipad and reposition it, before announcing the start of the first manoeuvre, to accommodate wind conditions. If the engine stops the flight is terminated.

After the flight: In case of electric motors, the battery must be disconnected before the pilot brings the helicopter over the judging line.

INTERRUPTION OF A COMPETITION

If the wind component perpendicular to the flight line exceeds 8ms/s for a minimum of 20 seconds during a flight, the competition must be interrupted. The flight will be repeated and the competition continued as soon as the wind subsides below the criterion. If the wind does not subside before the round is completed, the entire round will be dropped. The determination will be made by the organiser with concurrence of the FAI Jury.

5.4.14. Manoeuvre Schedules

FLIGHT PROGRAM

The flight program consists of manoeuvre schedules P and F for the years 2016 - 2017. Each schedule consists of nine (9) manoeuvres (see ANNEX 5D - F3C MANOEUVRE DESCRIPTIONS).

PERFORMANCE OF THE SCHEDULES

The competitor must stand in the 2m circle (labelled P in Figure 5.4.A - F3C Contest Area Layout) located 6m in front of the centre judge. Before the start of the first manoeuvre the pilot may fly or carry the model to the helipad. If the model is flown to the helipad then it must be flown at a height of 2 m (for safety reasons.) Alternatively, the helper may carry the model aircraft to the helipad.

The model aircraft may face left or right but must be parallel with the judges' line.

Each hovering manoeuvre ends with a landing on the helipad and after each landing the model aircraft may be repositioned (but maintains same direction) prior to the next takeoff. After completing the hovering manoeuvres the competitor is allowed one free pass to set up for the flying sequence.

All aerobatics manoeuvres must be performed in an airspace that will allow them to be clearly seen by the judges. This airspace is defined by a field of view up to 60° above the horizon and between lines 60° to the right and left of judges 1 and 5. The non-observance of this rule will be penalised by a loss of points.

The aerobatics manoeuvres must be performed in a smooth flowing sequence, with a manoeuvre performed on each pass before the judges. There are no restrictions on turnaround manoeuvres.

The competitor must perform each listed manoeuvre only once during a flight. The competitor or his caller must announce the name (number) and start and finish of each manoeuvre. A manoeuvre performed out of sequence will result in a zero score for that manoeuvre only. Before the autorotation manoeuvre the competitor is allowed another free pass to accommodate a possible change in wind direction.

5.4.15. Manoeuvre Descriptions and Diagrams

Refer to ANNEX 5D

5.4.16. Judges' Guide

Refer to ANNEX 5E

FIGURE 5.4.A - F3C CONTEST AREA LAYOUT

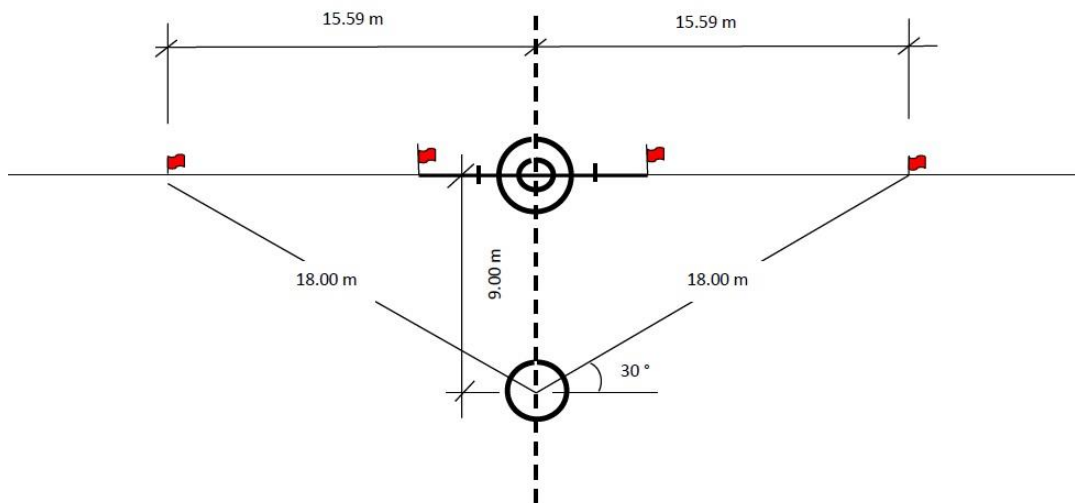
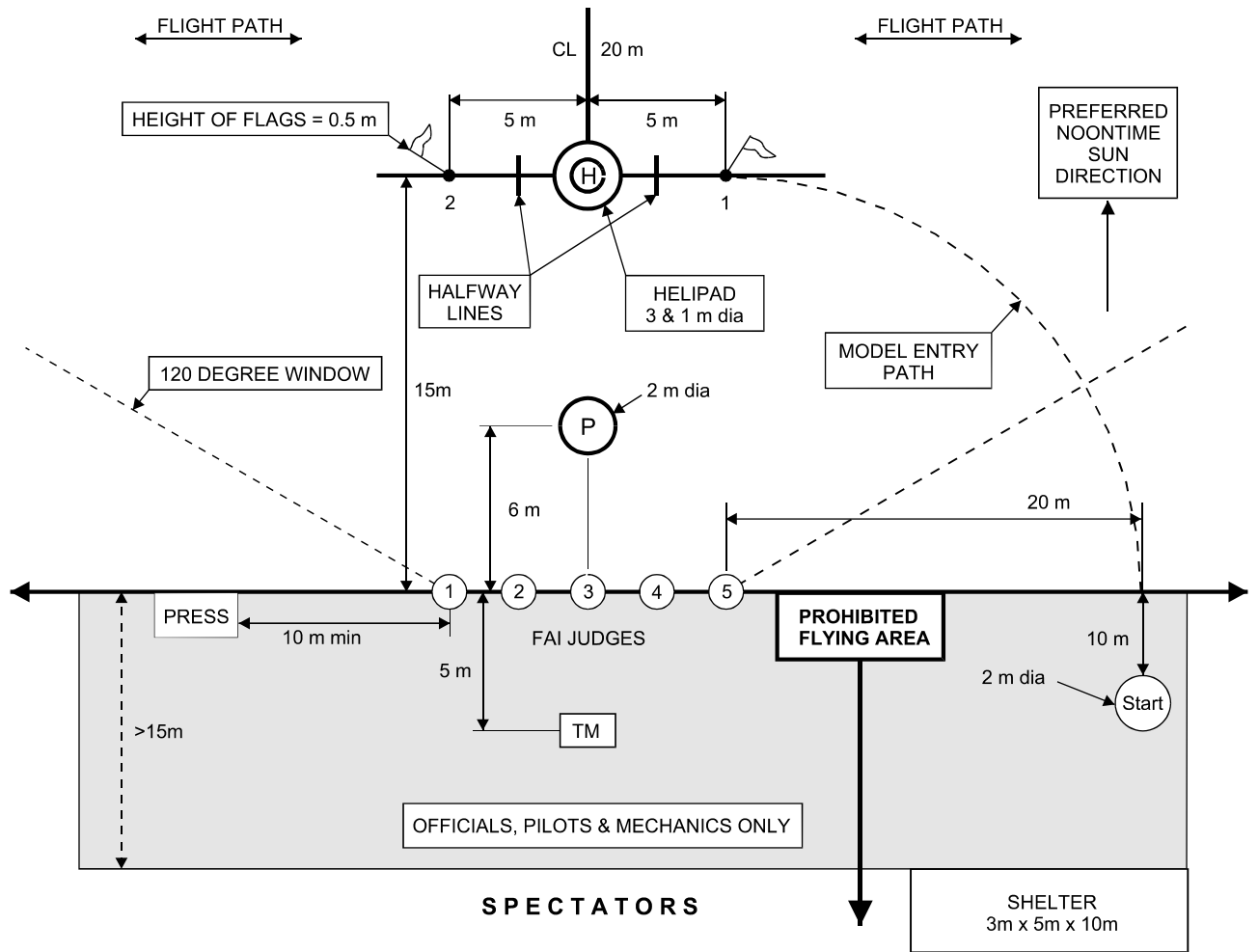

Marking the 120 ° sector for the pilot with flags

PAGE DELIBERATELY LEFT BLANK

ANNEX 5D**F3C MANOEUVRE DESCRIPTIONS AND DIAGRAMS**

The manoeuvre schedules are listed below with the starting and ending direction (UU = Upwind - Upwind; DD = Downwind - Downwind; DU = Downwind - Upwind; UD = Upwind - Downwind) of each manoeuvre, relative to the wind, as indicated. The competitor has 9 minutes to complete each schedule. Schedule P will be flown for the preliminary rounds 1 through 4. Schedule F will be flown for the Fly-Off rounds.

SCHEDULE P

P1. FLOWER	(UU)
P2. CUP	(UU)
(FLY BY)	
P3. DOUBLE CANDLE WITH DESCENDING FLIP	(DD)
P4. PULLBACK WITH 3 HALF LOOPS	(UU)
P5. UX	(DD)
P6. OVAL WITH TRAVELLING FLIP	(UU)
P7. OPPOSITE HALF AND FULL INVERTED ROLL	(DD)
P8. LOOP WITH FLIP	(UU)
(FLY BY)	
P9. AUTOROTATION WITH LOOP	(DD/UU)

SCHEDULE F

F1. UMBRELLA.....	(UU)
F2. FIR-TREE.....	(UU)
(FLY BY)	
F3. CUBAN-EIGHT WITH 360° FLIPS	(DD)
F4. OVAL WITH FLIPS AND FOUR-POINT-ROLL	(UU)
F5. DOUBLE CANDLE WITH HALF ROLLS AND DESCENDING FLIPS.....	(DD)
F6. X	(UU)
F7. STANDING EIGHT WITH HALF ROLLS.....	(DD)
F8. PULLBACK WITH 2 HALF AND 1½ LOOPS.....	(UU)
(FLY BY)	
F9. AUTOROTATION WITH FLIPS AND PIROUETTE.....	(DD/UU)

5D.1 General

The manoeuvres are displayed in pictorial form in Figures 5D-P and 5D-F for the case where the wind direction is left to right. The following descriptions apply to all manoeuvres and if not performed properly must result in downgrades. Points will also be subtracted if a manoeuvre is not performed as described. The starting/ending altitude for the hovering manoeuvres is 2m above the helipad. If a manoeuvre is unrecognisable it must be severely downgraded. If pirouettes are performed in the wrong direction, the score shall be zero (0) points. Ascents from, and descents to, the helipad must be vertical. Landings must be smooth and centred on the helipad. During the hovering manoeuvres all stops must be of 2 seconds minimum duration (unless specified otherwise). Circular and linear hovering segments must be performed at a constant speed. Every pirouette must be performed at a constant turning rate. The hovering manoeuvres must be started with the nose of the model aircraft (MA) facing left or right and must be flown as a unit (the starting heading must be same for each hovering manoeuvre). The competitor must stand in the 2m diameter circle marked "P" in Figure 5.4.A during all manoeuvres. All aerobatic manoeuvres must start and end in the direction indicated with a straight and level flight line of 10m minimum length. Entry and exit must be at the same altitude and heading. Loops or parts of a loop must be round and have the same diameter. Consecutive loops must be in the same location and plane. Rolls must be performed at a constant roll rate. Consecutive rolls must have the same roll rate and must be at the same altitude and heading. During all aerobatics manoeuvres the competitor must maintain his MA above a minimum altitude of 10 m. Aerobatic manoeuvres must be centred within the 120° horizontal field of view and must be symmetrical about the centre line. Aerobatic manoeuvres flown at a distance greater than

100m from the judges' line will be downgraded. In case of a dispute the manoeuvre text takes precedence over Figures 5D-P and 5D-F.

Note: When the word "centred" is used, it means that the MA crosses an imaginary plane that extends from a line drawn vertically upward, from the centre judge out through the helipad. This refers to both Schedules P and F.

Scoring criteria for landing; See ANNEX 5E paragraph 5E.6.10.

5D.2 SCHEDULE P

P1: Flower (UU)

K=1.5

MA take off vertically from the helipad and ascends to 2m and hovers for a minimum of 2 seconds, ascend backwards while performing a quarter of a 5m radius circle and stops over flag 1 (2), hovers for a minimum of 2 seconds and then performs half of a 5m radius circle while simultaneously performing a full 360° pirouette and stops over flag 2 (1). MA hovers for a minimum of 2 seconds, descends backwards while performing a quarter of a 5m radius circle and stops over the helipad hovers for a minimum of 2 seconds, descends and lands in the helipad.

P2: Cup (UU)

K=1.5

MA takes off vertically from the helipad and ascends to 2 m while performing simultaneously a 180° pirouette. It hovers there for at least 2 seconds, ascends flying backwards describing the lower left (right) quarter of a circle with 5 m radius while simultaneously performing a 180° pirouette in any direction, stops over the flag for at least 2 seconds, hovers to the other flag while simultaneously performing two 180° pirouettes that are in opposite direction, stops and hovers over the flag for at least 2 seconds, descends describing the lower right (left) quarter of a circle with 5 m radius while simultaneously performing a 180° pirouette in any direction, stops over the center line for at least 2 seconds, descends and lands into the helipad while simultaneously performing a 180° pirouette in any direction.

Note 1: The change of the pirouettes direction must be done smoothly on the centre line.

P3: Double candle with descending flip (DD)

K=1.0

MA flies straight and level for a minimum of 10 m and pulls up into a vertical ascent. After a nose up stop MA flies backwards vertically for 2m minimum performs a half pulled travelling flip, descends vertically for a minimum of 2m, performs a centred half loop and ascends vertically. After a nose up stop MA flies backwards vertically for 2m minimum, performs a half pulled travelling flip, descends vertically for 2m minimum and then pulls into horizontal straight and level flight for a minimum of 10m.

Note: The 2 flips must be made at the same altitude.

P4: Pullback with 3 half loops (UU)

K=1.0

MA flies straight and level for a minimum of 10m and pulls up into a vertical ascent. After coming to a stop, MA performs a half backward loop. After a vertical tail up, stop, MA performs a centred inverted half loop. After a vertical nose up, stop, MA performs a half backward loop. After a vertical tail up, stop, MA performs a vertical descent. MA pulls into horizontal straight and level flight for a minimum of 10m at the same altitude as entered.

Note: The 3 half loops must be of the same radius & altitude.

P5: UX (DD)

K=1.0

MA flies straight and level for a minimum of 10m and pulls up into a 45° ascent with a centred half roll. Once the MA has come to a stop, MA performs a 135° pulled flip, performs a centred 'U', stop, performs a 135° pulled flip, performs a 45° descent with a centred half roll. MA pulls into horizontal straight and level flight for a minimum of 10m.

Note: The bottom of the 'U' and the rolls must be centred.

cont/ ...

P6: Oval with travelling flip (UU)**K=1.0**

MA flies straight and level for a minimum of 10m and pulls up into a half loop, flies inverted for a minimum of 1 second, performs a travelling 360° centred pushed flip, flies inverted for a minimum of 1 second performs a half loop. MA pulls into horizontal straight and level flight for a minimum of 10m.

P7: Opposite half and full inverted rolls (DD)**K=1.0**

MA flies straight and level for a minimum of 10m and performs a half roll in either direction, flies inverted for a minimum of 1 second, performs a full centred inverted roll in the opposite direction, flies inverted for a minimum of 1 second, performs a half roll in the same direction as the first half roll. MA flies straight and level flight for a minimum of 10m.

Note: The middle of the manoeuvre must be centred.

P8: Loop with flip (UU)**K=1.0**

MA flies straight and level for a minimum of 10m and pulls up into a full centred loop with a full centred transitional pulled flip on top. MA pulls then into horizontal straight and level flight for a minimum of 10m.

Note 1: The flip trajectory must be included in the loop path.

Note 2: The flip must be 1/4 of the loops trajectory.

P9: Autorotation with loop (DU)**K=1.0**

MA flies straight and level for a minimum of 10m and performs a centred loop and cuts the engine (or at idle) at the top of the loop, completes the loop with the engine off (or at idle) enters a descending 180° turn toward the pilot and land upwind.

Note 1: An excessively high entry level will be 1 point downgraded.

Note 2: The descent rate must be constant from the end of the loop to a point just before touchdown on the helipad.

Note 3: The flight path of the MA must appear as a half circle when viewed from above.

5D.3 SCHEDULE F**F1: Umbrella (UU)****K=1.5**

MA takes off vertically from the helipad and ascends to 2m and hovers 2 seconds minimum, performs a half 2,5m radius circle while performing a 180° nose in pirouette and stops over flag 1 (2), hovers 2 seconds minimum, performs a half 5m radius circle while performing a 360° pirouette in either direction and stops over flag 2 (1), hovers 2 seconds minimum, performs a half 2,5m radius circle while performing a 180° nose in pirouette and stops over helipad, hovers 2 seconds minimum and descends to helipad and lands.

F2: Fir-tree (UU)**K=1.5**

MA takes off vertically from helipad and ascends to 7 m while simultaneously performing a 450° pirouette. It stops with its nose pointing to the pilot and hovers for at least 2 seconds, descends (any direction) at a 45° angle while simultaneously performing a 180° pirouette in any direction, stops over the flag 1 (2) and hovers for at least 2 seconds, hovers to the other flag 2 (1) while simultaneously performing two 180° pirouettes that are in opposite direction and hovers for at least 2 seconds, ascends at a 45° angle while simultaneously performing a 180° pirouette in any direction and stops for at least two seconds with its nose pointing to the pilot.

MA descends vertically 7 m to the helipad while simultaneously performing a 450° pirouette that must be in the opposite direction than the pirouette at the beginning of the figure and lands in the helipad.

Note 1: If at the start of the figure the nose of the MA points to the left then the ascending pirouette must be in left direction also.

Note 2: If at the start the nose of the MA points to the right then the ascending pirouette must be in right direction.

Note 3: The change of the pirouettes direction must be done smoothly on the centre line.

F3 Cuban-eight with 360° flips (DD)**K=1.0**

MA flies straight and level for a minimum of 10 m before crossing the centre line. MA crosses the centre line and performs 3/4 of an inside loop, flies 45° downwards while performing a pushed, centred 360° flip, performs 3/4 of an outside loop, flies 45° downwards while performing a pulled, centred 360° flip. MA pulls into horizontal straight and level flight for a minimum of 10 m at the same altitude as when entering the figure.

Note 1: Before and after the flip the MA may fly a straight line. All straight lines must have the equal length corresponding also to the pushed flip.

F4 Oval with flips and four-point-roll (UU)**K=1.0**

MA flies straight and level for a minimum of 10 m before crossing the centre line, crosses the centre line and performs a half inside loop, performs two pushed 360° flips in the horizontal flight, performs a half inside loop that ends at same height as when entering the figure, performs a four-point-roll, flies horizontal straight and level for a minimum of 10 m.

Note 1: Before and after the flips the MA may fly a straight line on its back, both lines must have the same length. The first 360° flip must end exactly on the centre line.

Note 2: Before performing the four-point-roll the MA may fly a straight line. However, the inverted flight phase of the four-point-roll must end exactly on the centre line.

F5 Double candle with half rolls and descending flips (DD)**K=1.0**

MA flies straight and level for a minimum of 10 m and after crossing the centre line pulls up into vertical ascent by doing a quarter inside loop and coming to a stop. MA flies vertically backwards while simultaneously doing half a roll in any direction, performs a half pushed flip in the downward flight, performs a centred half inside loop, flies vertically up coming to a stop, flies vertically backwards while simultaneously doing half a roll in any direction, performs a half pulled flip in the downward flight, performs a quarter inside loop ending at the centre line followed by a horizontal, straight and level flight for a minimum of 10 m at the same altitude as when entering the figure.

Note 1: The quarter loops and the half loop must have the same radius and must be congruent.

Note 2: The rolls and flips must be executed at the same altitudes.

F6: X (UU)**K=1.0**

MA flies straight and level for a minimum of 10m and pulls up into a 45° ascent with a centred half roll. When MA stops, it performs a centred, horizontal 3/4 transitional pushed flip performs a 45° descend with a centred half roll. MA pulls into horizontal straight and level flight for a minimum of 10m.

Note: The bottom of the triangle must be centred.

F7 Standing eight with half rolls (DD)**K=1.0**

MA flies straight and level for a minimum of 10 m, performs a half roll and flies inverted, straight and level for a minimum of 1 second. MA flies then an outside loop upwards, followed by a inside loop downwards, flies inverted, straight and level for a minimum of 1 second at the same altitude as when entering the figure, performs a half roll and flies straight and level for a minimum of 10 m.

Note 1: Both inverted flights at beginning and ending of the figure must be of identical length measured in time as well as in distance, the duration must be in minimum one second.

Note 2: The half rolls may be executed in any direction. Both loops must have the same radius.

F8 Pullback with 2 half and 1 1/2 loops (UU)**K=1.0**

MA flies straight and level for a minimum of 10 m, crosses the centre line and pulls up into vertical ascent by doing a quarter inside loop. After coming to a stop, MA performs a half backward inside loop. When the tail is vertical and the MA has stopped, it performs one and a half centred outside loops. When the nose is vertical and the MA has stopped, it performs again a half backward inside loop. When the tail is vertical and the MA

has stopped, it descends vertically, then does a quarter inside loop and goes into horizontal straight and level flight for a minimum of 10 m at the same altitude as when entering the figure.

Note: the radius of all loops must be the same (quarter loops, half loops, one and a half loop)

F9 Autorotation with flips and pirouette (DD/UU)

K=1.0

MA flies straight and level for a minimum of 10 m, pulls up into vertical ascent by doing a quarter inside loop before the centre line. After coming to a stop it performs a pulled quarter flip and hovers for 2 seconds, executes in a minimum of 3 seconds a 360° pirouette in inverted position, hovers for a minimum of 2 seconds and powers off the engine, performs a pulled quarter flip with powered off engine, flies a positive quarter loop until it reaches the centre line, executes from the centre line a constantly descending 180° curve in the direction of the pilot and lands against the wind on the helipad.

Note 1: An excessively high entry level will result in one point deduction.

Note 2: The radius of the quarter loop is equal to the distance from the centre line.

Note 3: The descent rate of the 180° curve must be constant from the centre line to a point just before touchdown on the helipad.

Note 4: The flight path of the MA must appear as a half circle when viewed from above.

Note: Manoeuvre diagrams are overleaf.

FIGURE 5D-P: F3C MANOEUVRE SCHEDULE P

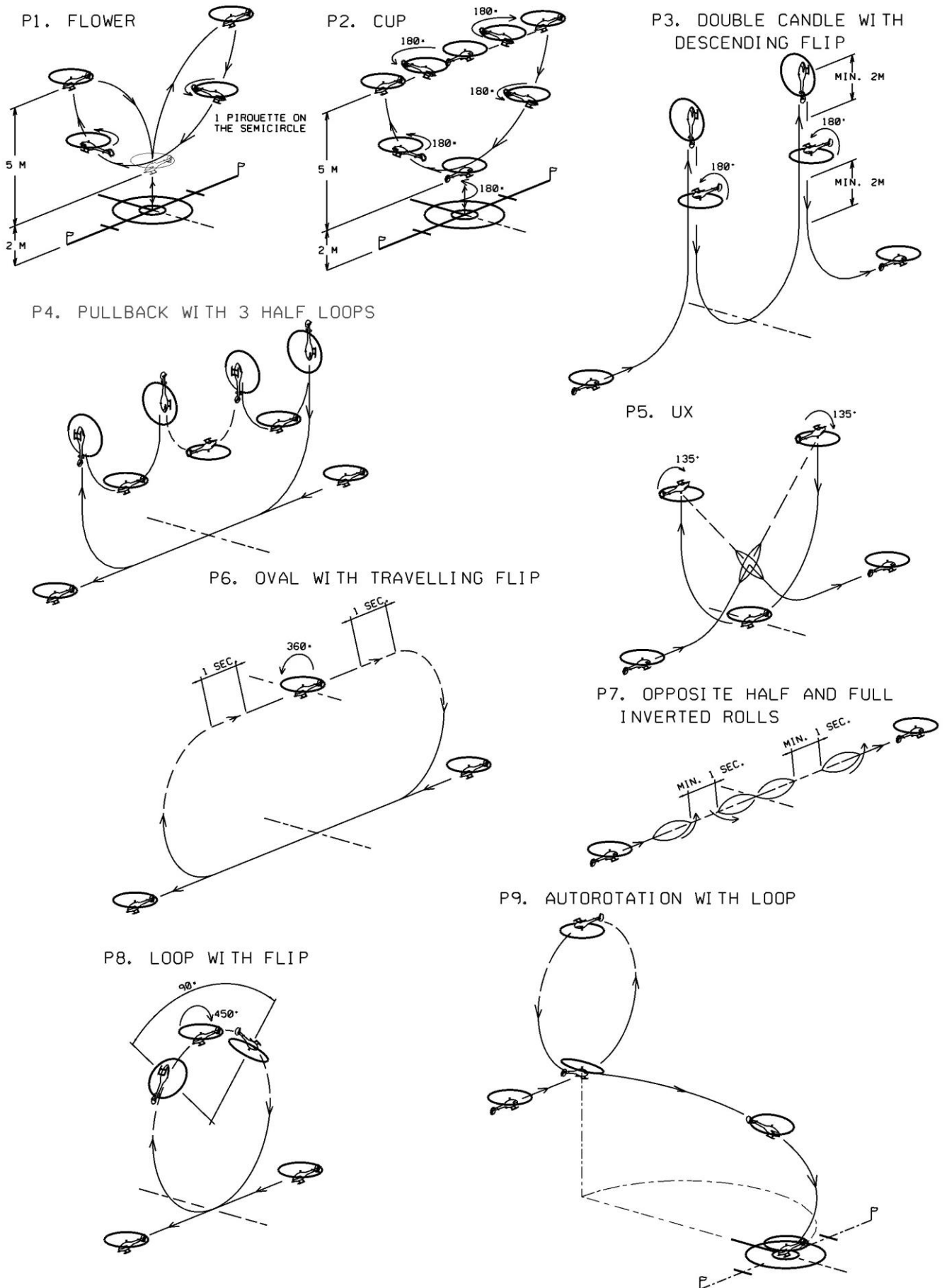
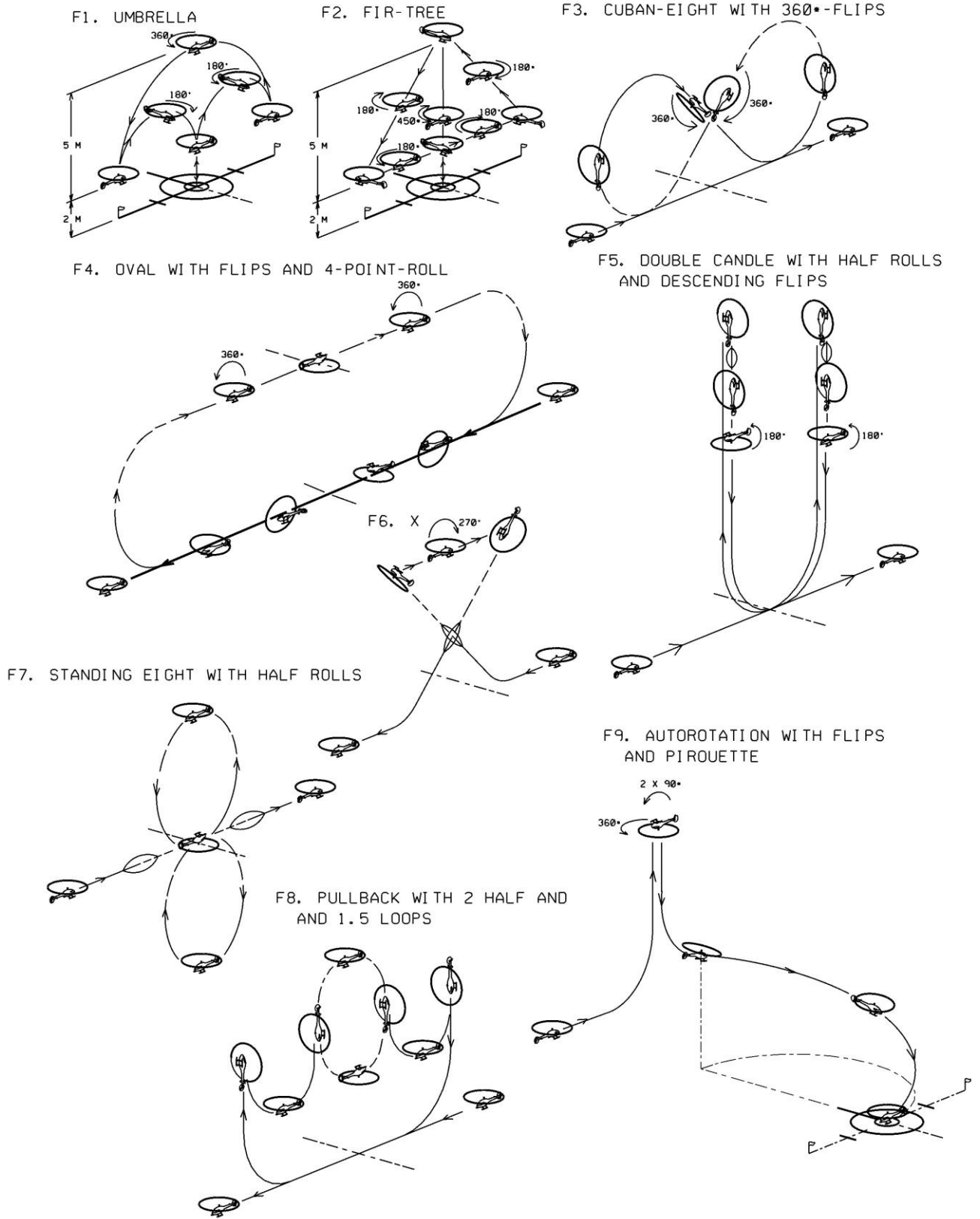

FIGURE 5D-F: F3C MANOEUVRE SCHEDULE F



ANNEX 5E

F3C JUDGES' GUIDE

5E.1 PURPOSE

The purpose of the F3C Judges' Guide is to provide an accurate description of the major judging criteria to serve as a reference for use in developing a uniformly high standard of judging.

5E.2 PRINCIPLES

The principles of judging a radio controlled model helicopter should be based on the perfection with which the MA performs each manoeuvre as described in Annex 5D.

The main principles used to judge the degree of perfection are:

- 1) Precision of the manoeuvre.
- 2) Smoothness and gracefulness of the manoeuvre.
- 3) Positioning or display of the manoeuvre.
- 4) Size of the manoeuvres relative to each other.

The requirements are listed in order of importance; however, all of them must be met for a manoeuvre to receive a high score.

5E.3 ACCURATE AND CONSISTENT JUDGING

The most important aspect of judging is consistency. Each judge must establish his standard and then maintain that standard throughout the competition. It is recommended that the contest director or organiser hold a conference prior to the start of competition to discuss judging so that the standards are as uniform as possible. This can be accomplished with demonstration flights that all judges score simultaneously and privately. After these flights, the defects in each manoeuvre should be discussed by all judges and agreement reached about the severity of the defects. After the competition is started, the individual judges should not alter their standard. Judging accuracy is also very important. Being consistent, whether high or low is not sufficient if the scores awarded do not fairly reflect the performed manoeuvre.

5E.4 CRITERIA FOR JUDGING MANOEUVRES

A description of each manoeuvre is provided in Annex 5D. Each manoeuvre should be downgraded according to:

- 1) The type of defect.
- 2) The severity of the defect.
- 3) The number of times a defect occurs.
- 4) The positioning of the manoeuvre.
- 5) The size of the manoeuvre relative to other manoeuvres.

A high score should be given only if no major defects are noted and the manoeuvre is accurately positioned. Whenever there is doubt a lower score should be given.

5E.5 ATTITUDE AND FLIGHT PATH

The flight path of the MA is the trajectory of its centre of gravity. The attitude is the direction of the fuselage (canopy, boom, etc) centreline in relation to the flight path. All judging should be based on flight path, but the angle between the flight path and the longitudinal axis should never exceed 10°.

5E.6 GRADING CRITERIA FOR MANOEUVRE SEGMENTS

The following criteria are furnished to provide the judge with a guide for downgrading deviations from the defined manoeuvre segments. The segments are: Takeoffs, Landings, Stops, Lines, Pirouettes, Loops, Rolls, Stall turns and Flips.

5E.6.1 TAKEOFFS

Takeoffs for the hovering manoeuvres must start from the centre of the 1m circle to obtain maximum score. Takeoffs must be smooth and the MA must ascend vertically until the skids or landing gear are at 2m over helipad. Non-vertical ascents where the MA moves forward or backward by half a fuselage length result in a downgrade of 1 point.

5E.6.2. LANDINGS

Landings for the hovering manoeuvres must be centred in the 1m circle of the helipad to obtain a maximum score. If a portion of the skids or landing gear is outside of the 1m circle (but rotor shaft points to the inside of the 1m circle when viewed from above), the downgrade is one point. A landing outside of the 1m circle (rotor shaft points to the outside of the 1m circle when viewed from above) results in a downgrade of 2 points. Non-vertical descents where the MA moves forward or backward by half a fuselage length result in a downgrade of 1 point.

5E.6.3 STOPS

For the hovering manoeuvres the stops must be equal to or greater than 2 seconds in duration if not otherwise specified. All stops must be of the same duration. If a stop is less than 2 seconds long, a downgrade of half a point should be made. If a stop is greater than 2 seconds, no downgrade should result as long as the MA does not move. In manoeuvres containing stops of unspecified duration (but are a necessary part of the manoeuvre) no downgrade shall be made for the stops.

5E.6.4. LINES

For the hovering manoeuvres the lengths of the lines are defined by the 10m distance between flags 1 and 2 and must be straight. Diagonal lines must be performed at the proper angle. However, the aerobatic manoeuvres must be started and ended by equal horizontal lines of minimum length 10 m. A greater length of a vertical or climbing line, resulting from the performance of the MA, must not be allowed to positively influence a judge's score. One point should be subtracted for a recognisable difference. If there is a complete absence of a line, before or after a manoeuvre, 2 points should be subtracted.

5E.6.5. PIROUETTES

All pirouettes must be performed around the vertical axis. If the deviation is greater than 20° one point will be subtracted. During a hovering pirouette (stationary tail rotor turn), if the MA moves vertically or laterally by a noticeable amount, 1 point should be subtracted. If the vertical or lateral movement of the helicopter is significant (more than 25cm), 2 or more points should be subtracted. During an ascending pirouette, if the MA moves laterally by a noticeable amount, 1 point should be subtracted. If the MA's movement is greater than 25cm, 2 or more points should be subtracted. Travelling pirouettes must be synchronised with flight path. If the pirouettes are performed in the same direction for manoeuvres where pirouettes of opposite direction are prescribed, the score must be zero.

5E.6.6. LOOPS

A loop must, by definition, have a constant radius, and must be flown in a vertical plane. It starts and ends with a well-defined line, which for a complete loop will be horizontal. Every loop must be flown without segmentation. Every clearly seen segment should result in a downgrade of 1 point. If a loop is not flown entirely in a vertical plane, a minor drift should be downgraded by 1 point, while a more severe drift should be downgraded by several points.

5E.6.7. ROLLS

The roll rate must be constant. Small variations in roll rate should be downgraded by 1 point while more severe variations receive larger downgrades. Rolls (including partial rolls) must have crisp and well-defined starts and stops. If a start or stop is badly defined, 1 point is subtracted for each. Duration of the rolls must meet the minimum times specified.

5E.6.8. TAIL TURNS

The tail turns must be symmetrical by performing half of the rotation before and after the top. The tail turn must be around the main rotor shaft. If there is significant horizontal displacement, 1 point should be subtracted. The entry and exit must consist of partial loops with constant and equal radii.

5E.6.9 STALL TURN

The lines during this segment must describe vertical and horizontal flight paths. The model aircraft must come to a complete stop before a tail rotor turn is initiated. The tail rotor turn must be around the main rotor shaft. If there is significant horizontal displacement, one point should be subtracted. If the model aircraft shows a pendulum movement after the rotation, this should result in a downgrade of one point. The entry and exit must consist of partial loops with constant and equal radii.

cont/...

5E.6.10. FLIPS

Flips are stationary or travelling rotations about the lateral (elevator) axis of the MA. The direction of the flip is described according to the movement of the (elevator/longitudinal cyclic) control stick (Push = Negative - Nose down, Pull = Positive - Nose up). For the case of a stationary flip, one point should be subtracted if the MA moves forward or backward more than a fuselage length. For the case of a travelling flip, one point should be subtracted for a deviation of more than a fuselage length from the path of the described manoeuvre.

5E.6.11. AUTOROTATIONS

An autorotation begins when MA crosses an imaginary plane that extends vertically upward from a line drawn from the centre judge out through the centre of the 1m helipad. MA must be in the autorotation state when it cuts this plane, the engine power must be reduced to idle (or off) at this point and the MA must be descending. During the manoeuvre, the forward speed and rate of descent should be constant, which means that the angle of the flight path is also constant. After landing the MA must be parallel to the judges' line. If the flight path is stretched, shortened or deviated from, to reach a circle the manoeuvre must be downgraded. The original flight path gives a basic maximum score according to the description and there will be additional downgrades of 1 or 2 points depending of the severity of the deviation. For example: If the flight path clearly points to a landing close to flag 1 (2) and the path is stretched to reach a circle, the score can only be a maximum of 6 (outside the circles) and there will be an additional downgrade of 2 points for the stretch, so the score can only be a maximum of 4. If the model lands without stretching, the maximum score would have been a 6. Therefore, stretching the flight path must never lead to a higher score.

Scoring criteria for Autorotation landings:

Landing gear inside 1m circle = Maximum 10 points.

Rotor shaft points to inside of 1m circle = Maximum 9 points.

Landing gear inside 3m circle = Maximum 8 points.

Rotor shaft points to inside of 3m circle = Maximum 7 points.

Rotor shaft points to outside of 3m circle = Maximum 6 points.

5E.7 WIND CORRECTION

All manoeuvres are required to be wind corrected in such a way that the shape of the manoeuvre as described in Annex 5D is preserved in the MA's flight path.

5E.8 POSITIONING

All aerobatic manoeuvres must be performed within the 60° vertical and 120° horizontal viewing angle. Manoeuvres that are flown off centre will be downgraded according to the displacement. The downgrade may be in the range of 1 to 4 points. If a portion of a manoeuvre is flown outside of this air space a severe downgrade will occur. If the entire manoeuvre including entry and exit is flown outside of the window it must be scored zero points. Flying so far out as to make the evaluation of a manoeuvre difficult should also be severely downgraded. The main criterion here is visibility. Manoeuvres performed on a line further out than 100m away but in front of the judges should be downgraded in any case because even the keenest eye begins to lose perspective at that distance.

PAGE DELIBERATELY LEFT BLANK

5.11 CLASS F3N – RC FREESTYLE AEROBATIC HELICOPTERS

5.11.1 Definition of a Radio Controlled Model Helicopter

A Radio Controlled (R/C) model helicopter is a heavier-than-air Model Aircraft (MA) that derives all of its lift and horizontal propulsion from a power driven rotor system(s) rotating about a nominally vertical axis (or axes). Fixed horizontal supporting surfaces up to 4 percent of the swept area of the lifting rotor(s) are permitted. A fixed or controllable horizontal stabiliser of up to 2% of the swept area of the lifting rotor(s) is permitted. Ground effect machines (hovercraft), convertiplanes or aircraft that hover by means of propeller slipstream(s) deflected downward are not considered to be helicopters.

5.11.2 General Characteristics

The swept area of the lifting rotor is not limited. The engine displacement is not limited. The use of pre-programmed flight manoeuvres is forbidden.

Limitations are:

- a) WEIGHT: The weight of the MA (with fuel or with batteries) must not exceed 6,5 kg.
- b) BATTERIES: Electric motors are limited to a maximum no load voltage of 51 volts for the propulsion circuit.
- c) ROTOR BLADES: All-metal main or tail rotor blades are prohibited.

5.11.3 Contest Area Layout

Refer to Figure 5.11.A. The drawing shows the recommended layout, the shape and distances of which should be kept for safety reasons. The centreline must be clearly indicated 20m out from the helipad.

5.11.4 Number of Helpers

After leaving the start box, the pilot is allowed one helper. The helper may give information to the pilot during the flight.

5.11.5 Number of Model Aircraft

The number of MA is not limited.

5.11.6 The Official Flight

There are three different flight programs: Set Manoeuvre flight, Freestyle flight and Music Freestyle flight. Before the flight the pilot has to be officially called. The MA can be flown or be carried to the flying area. The flight time begins when the pilot or his helper gives a distinctive hand signal, and finishes with another distinctive hand signal.

5.11.7 Scoring

The number of judges is at least three, and no more than five. At least 20% but not more than 40% of the judges must not have judged at the previous World Championships.

In the Set Manoeuvre flight each manoeuvre is given a score between 0 and 20 points by each judge. A manoeuvre that is not completed or not flown according to the description shall be scored zero (0) points. If a manoeuvre is scored zero points all judges must agree. In the freestyle or music freestyle flights the scoring is done after the flight according to the scoring criteria.

In the Set Manoeuvre flights, only manoeuvres that are completed in the flight time of 8 minutes will receive a score. If the flight time for the Freestyle or Music Freestyle program is less than three or more than four minutes, there shall be a downgrade of 5% for the flight. A flight shorter than two or longer than five minutes shall be scored zero points.

Manoeuvres must be performed where they can be seen clearly by the judges. If a judge, for some reason beyond the control of the competitor, is not able to follow the model aircraft through the entire manoeuvre, he may put a "Not Observed" (N.O.) mark. In this case, his score will, for that particular manoeuvre, be set to the average score given by the other judges, rounded to the nearest whole point.

5.11.8 Classification

After the completion of every round, all scores will be normalised by awarding 1000 points to the highest scoring flight. The remaining scores are then normalised to a percentage in the ratio of actual score over the highest score of the round. The scores should be calculated to at least two decimal places and recorded (truncated) to two places after decimal point.

There shall be two rounds of Set Manoeuvre flights and one round each for Freestyle and Music Freestyle. However, the lowest score of each competitor will be the throwaway score. The other scores are added together and then divided by the number of counting preliminary rounds.

The result is the preliminary score. If only one round is possible then the classification will be based on that round.

After completion of the preliminary flights, the top 10 competitors are entitled to three fly-off flights, one Set Manoeuvre flight, one Freestyle and one Music Freestyle flight. The normalised results of the preliminary rounds for the top 10 pilots plus the three fly-off scores provide four normalised scores with the best three to count for the final individual classification.

At national and open international competitions the preliminary/fly-off system is not mandatory.

Ties will be broken by counting the throwaway score. If the tie still stands, a “sudden death” freestyle fly-off must take place until a decision is made.

The team classification for World and Continental Championships is established at the end of the competition (after the fly-off flights) by adding together the numerical final placings of the three team members using the full list of competitors unless there is a fourth member of the team (who must always be a junior) in which case it will be the three best placed members. Teams are ranked from the lowest numerical scores to the highest, with complete three-competitor teams ahead of two-competitor teams, which in turn are ranked ahead of one-competitor teams. In case of a tie, the best individual placing decides the team ranking. (Ref: *CIAM General Rules, C.15.6.2 i*)

5.11.9 Organisation

The flight order for the first Set Manoeuvre round will be determined by a random draw. The flight order for rounds two (Freestyle), three (Set Manoeuvre) and four (Music Freestyle) will start after the first, second and third quarter of the initial order. The flight order for the fly-offs will be determined in the same manner.

Preparation Time: A competitor must be called at least 5 minutes before he is required to enter the start box. The MA may be hovered only up to 2m in the start box. After the preceding competitor has finished his flight, the competitor is given another minute (two minutes in Freestyle) to make last minute adjustments or checks.

5.11.10 Flight Program

Safety During the Flights

The prohibited flying area (see figure 5.11.A) is observed by the judges. If the safety line is crossed the flight shall be scored zero points.

The competitor may choose his position during the flight with the following constraints:

- (a) The MA must not be flown between the pilot and judges.
- (b) The pilot must stand in front of the judges.

The non-observance of these constraints will be penalised by a zero score in the safety criterion for the manoeuvre or the flight in Freestyle.

If, during a flight in any of the schedules, a part of the helicopter except the landing gear or tail fin touches the ground the flight is terminated and scored zero points. This also applies to the MA tilting over after a landing or autorotation.

Set Manoeuvre Flight

Every pilot makes his choice of eight different manoeuvres from the list of manoeuvres (refer to paragraph 5.11.11). He may choose different manoeuvres for each round. The list with the manoeuvres chosen for a round must be delivered to the Contest Director or an official before the beginning of the round. The flight time of the Set Manoeuvre rounds is eight minutes.

Freestyle Flight

Each competitor is given a flight timeframe of at least three, and no more than four minutes. During this time there are no restrictions for the flight or the performed manoeuvres except those regarding safety. The play-back of music is not allowed. The flight time begins when the helper gives a distinctive hand signal and finishes only with another distinctive helper hand signal.

Music Freestyle Flight

The same criteria as in Freestyle, but the play-back of music during the flight is prescribed. The flight time begins when the helper gives a distinctive hand signal and finishes only with another distinctive helper hand signal. If the music starts before the flight, the flight time starts not later than 15 seconds after the start of the music.

5.11.11 Optional Manoeuvres

The Optional Manoeuvre list that is changed on a yearly basis after approval by CIAM Bureau will be available from the F3 Helicopter Subcommittee Chairman at the beginning of each year.

Note: It may not be possible to include in the F3 Helicopter volume of the Sporting Code the Optional Manoeuvres that are approved annually by Bureau at its December meeting.

The F3N Contest Area Layout appears below.

FIGURE 5.11.A – F3N CONTEST LAYOUT AREA

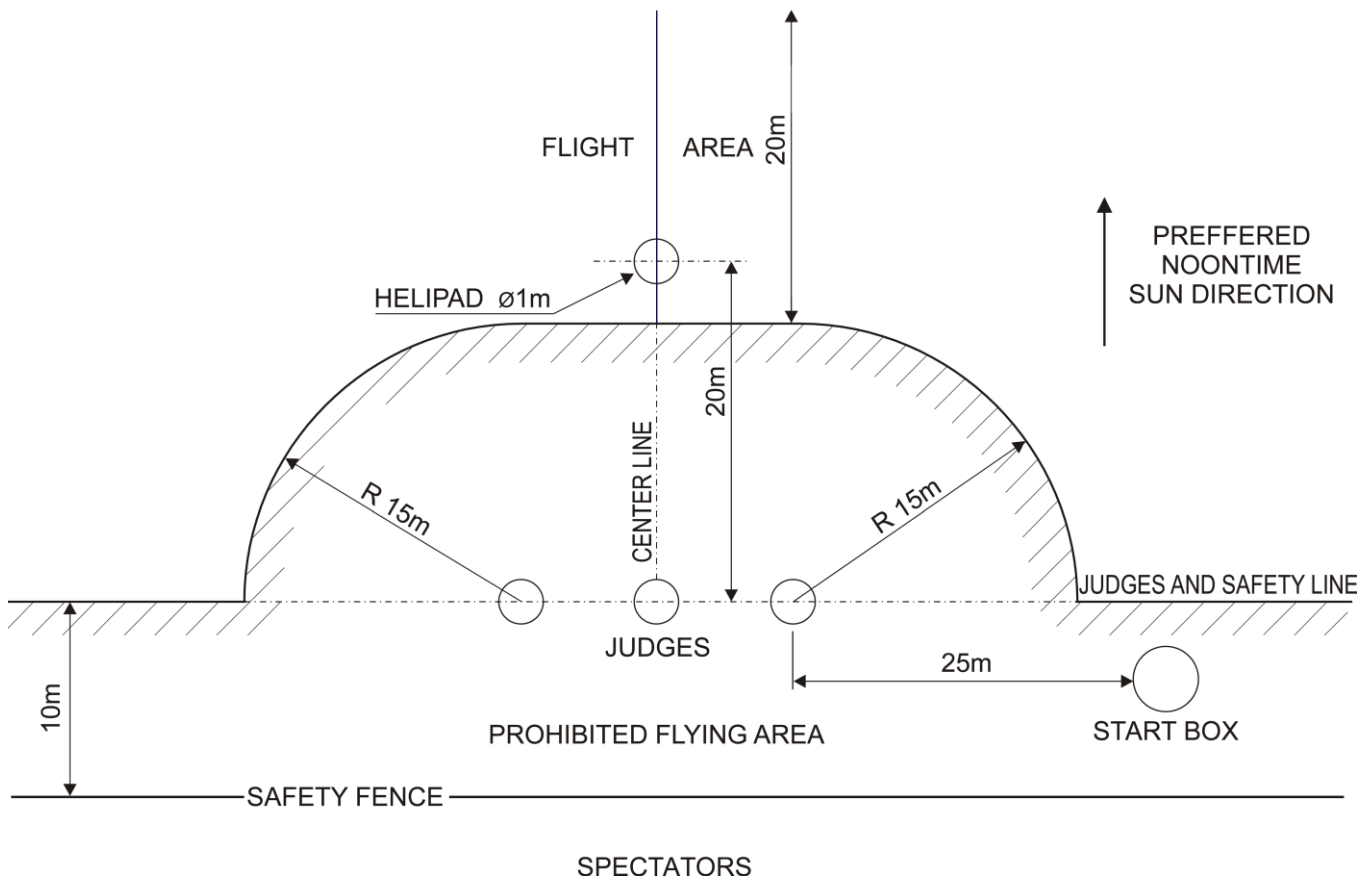

The manoeuvre descriptions appear on the next page.

ANNEX 5F

F3N MANOEUVRE DESCRIPTIONS AND DIAGRAMS

5F.1 F3N SET MANOEUVRE DESCRIPTIONS

- (a) The list of Set Manoeuvres contains 30 manoeuvres (listed below) and ten optional manoeuvres. The optional manoeuvres must be selected by the organiser at least 6 months prior to the competition from a list that is available from the F3 Helicopter Subcommittee Chairman. This list will be revised by the F3 Helicopter Subcommittee on a yearly basis and will be approved by the CIAM Bureau.
- (b) The competitor or his caller must announce the name and start and finish of each manoeuvre. All aerobatic manoeuvres start and end with a straight and level flight of 10 metres minimum length parallel to the judges' line. All manoeuvres from stationary flight start and end with a hovering of at least 1 second with the MA parallel or vertical to the flight line. All manoeuvres (considering also entry and exit) should be performed symmetrical to the centre line. The drawings in paragraph 5.11.12 illustrate the manoeuvres, in case of a dispute the following text takes precedence over the drawings. All manoeuvres can also be flown in opposite direction to that shown in the drawings.

Number	Description	K-Factor
1.1.	Double Immelmann MA performs a half inside loop immediately followed by a half roll to upright flight. After a straight flight of about 20 meters MA performs a half outside loop, again immediately followed by a half roll to upright flight.	K=4.0
1.2	Double roll backwards MA enters in upright backward flight and performs two consecutive axial rolls.	K=4.5
1.3	4-point roll MA enters in upright forward flight and then performs 4 quarter rolls, separated each by a recognizable straight segment of the same duration.	K=4.5
1.4	Outside loop with half rolls MA performs a half roll to inverted flight, followed by a recognizable straight segment and then enters an outside loop (upward). After the loop, MA flies another recognizable straight segment, followed by a half roll to upright flight.	K=5.0
1.5	Inverted horizontal eight MA enters in inverted forward flight parallel to the judges' line, performs a 90°-turn to a straight flight above the centre line and then performs a horizontal eight, consisting of two 360° circles. The manoeuvre is not intended as a hover manoeuvre. In case of low flying speed and banking angle less than 45deg, a maximum of 15 points can be given.	K=5.0
1.6	Backward knife edge pirouette MA enters in upright backward flight, transitions to a slight ascent (max 15°) and performs a quarter roll. After a recognizable straight segment MA performs a 360°-pirouette, followed by another straight segment and a quarter roll in opposite direction to the first to upright backward flight.	K=5.5
1.7	Four pushed half flips MA hovers in upright position, then performs four half pushed flips (forward) each separated by a hovering of 2 seconds. MA maintains its position during the manoeuvre.	K=5.5
1.8	Tic-toc (Metronome) MA hovers and then is rotated (Nose up) about 135°. It then starts rotating alternately about the lateral axis by about 90° forward or backward. Both 45° positions have to be reached at least three times. The tail rotor stays almost in the same position during the manoeuvre.	K=6.0
1.9	360°-turn with roll MA enters in upright forward flight and performs a quarter (inside) loop to a vertical climb. Just before the stall, MA performs a 360°-pirouette to a vertical (backward) dive, followed by another quarter (inside) loop to upright flight and an axial backward roll.	K=6.0

- 1.10 Backward loop** **K=6.5**
MA enters in upright backward flight and performs an inside loop with the tail always pointing in flight direction.
- 1.11 4-point roll backwards** **K=6.5**
MA enters in upright backward flight and then performs 4 quarter rolls, separated each by a recognizable straight segment of the same duration. The tail of the MA always points in the flight direction.
- 1.12 Inverted backwards horizontal eight** **K=7.0**
MA enters in inverted backward flight parallel to the judges' line, performs a 90°-turn to a straight flight above the centre line and then performs a horizontal eight, consisting of two 360° circles with the tail always pointing in flight direction.
- 1.13 Rolling circle** **K=7.5**
MA performs a horizontal circle while it performs consecutive axial rolls. MA speed, rolling rate and the radius of the circle should be constant.
- 1.14 4 rainbows with half rolls** **K=7.5**
MA performs a rainbow (a semicircle with the lateral axis always vertical to the flight path) to a recognizable stop, then a stationary half roll to another stop. Then it enters another rainbow to a stop on the position of the start of the manoeuvre, followed by another half roll and continues like that, until four rainbows and four half rolls are completed.
- 1.15 Funnel** **K=7.5**
MA enters in inverted flight and performs a quarter pirouette. MA then performs three superimposed circles in lateral inverted flight with the rotor disk tilt at least 45 degree from a horizontal plane. The diameter of the circles should be at least 10 meters.
- 1.16 Snake** **K=8.0**
MA enters in upright backward flight and then describes a sinuous line by alternately performing upright and inverted circle segments of equal diameter and length. There should be at least four complete circle segments and the length of the manoeuvre should be at least 50 meters.
- 1.17 Triple pirouetting flip** **K=8.0**
MA hovers and then starts pirouetting. At the same time or after one pirouette the MA starts to flip three times while it continues to perform pirouettes. There should be at least one pirouette during each 360° flip (2 pirouettes are shown in the drawing). Both rotations should have a constant rate and the MA maintains its position during the manoeuvre.
- 1.18 Cuban eight backwards** **K=8.0**
MA enters in upright backward flight and performs a 5/8 inside loop to a 45°-descent. It performs a half roll, followed by a 3/4 inside loop and another half roll in 45°-descent. MA then finishes the first partial loop to upright backward flight. The tail of the MA always points in the flight direction.
- 1.19 Pirouetting loop** **K=8.0**
MA enters in upright flight and starts performing pirouettes. Then it performs an inside loop while constantly rotating about the yaw axis. During the loop there have to be at least 2, max 6 pirouettes. The pirouettes should be distributed equal on the loop.
- 1.20 Backward rolling circle** **K=9.0**
MA enters in backward flight and performs a horizontal circle while it performs consecutive axial rolls. MA speed, rolling rate and the radius of the circle should be constant and the tail of the MA always points in the flight direction.
- 1.21 Waltz** **K=8.5**
MA enters in inverted flight and performs a quarter pirouette (tail turns to circle centre) to enter a funnel. After a quarter funnel MA performs a complete smaller funnel (max. half diameter of the first) then continues with another quarter larger funnel, followed again by a complete smaller funnel etc. After the larger funnel is completed there is again a complete smaller funnel, followed immediately by another quarter pirouette to the exit in inverted flight. The diameter of the large funnel should be at least 20 meters.

- 1.22 Double 4-point Tic-toc** **K=8.0**
 MA hovers and then is rotated (Nose up) 135°. It then starts rotating alternately about the lateral axis for about 45° in each direction. Both 45°-positions have to be reached one time (ie one tic-toc) and then the MA performs a quarter pirouette. It performs another tic-toc in this position, then again performs another quarter pirouette and so on, until it performed two complete pirouettes while executing tic-tocs. The quarter pirouette can either be performed just when the model reaches one of the 2 end positions, or integrated in the movement back, before the next tic-toc is performed.
- 1.23 Pirouetting funnel** **K=8.5**
 MA enters in inverted flight and then starts pirouetting whereas it performs three superimposed circles in lateral inverted flight with the rotor disk tilt at least 45 degree from a horizontal plane. The diameter of the circles should be at least 10 meters and there should be at least three pirouettes during each circle.
- 1.24 Four point tic-toc reversal** **K=9.0**
 MA hovers with the tail to the judges' line and is brought to vertical position (Nose up) about 135°. It then starts rotating alternately about the lateral axis for about 45° in each direction. Both 45°-positions have to be reached one time (i.e. one tictoc) and then the MA performs a quarter pirouette in clockwise direction. It performs another complete tictoc in this position, then again performs another quarter pirouette in clockwise direction and so on. After the MA has performed a complete pirouette, the MA starts immediately a second 4-time tictoc in anti-clockwise direction. The MA maintains its position during the manoeuvre.
- 1.25 Pirouetting globe** **K=9.0**
 MA enters in upright flight and then performs four pirouetting loops. During each loop, the flight path is changed in a way, that the next loop is rotated about 45° (seen from above) until a complete globe has been described. The MA exits the manoeuvre at the same altitude but in opposite direction to the beginning. During each loop, the MA must perform at least two pirouettes.
- 1.26 Duus Iglo** **K=9.0**
 Viewed from above, the manoeuvre shows an X. The centre point of the X is on the centre line. MA enters in 1 of the 4 outer points in the X in upright hovering and boom pointing to centre of X. Model then performs half pulled rainbow, while also doing an integrated half pirouette. Top of rainbow must be the centre of the X. Here model makes sharp quarter aileron roll, and completes second half of the rainbow while making another integrated half pirouette until model hovers inverted shortly. The boom still points to centre of the X, but now in another of the 4 outer points. Same sequence is then repeated 3 more times, until MA is back at starting point. Notice hovering is inverted after first and third sequence.
- 1.27 Rolling Circle Tail Reversal** **K=9.5**
 MA enters in forward upright flight parallel to judge line. Immediately after passing centreline, MA starts a horizontal rolling circle. After each quarter of the circle, MA performs half elevator flip. After half flip the roll input direction must be changed. After complete circle and four half flips, MA exits in forward upright flight. Speed and height of MA must be constant during complete manoeuvre.
- 1.28 Funnel with half rolls** **K=9.5**
 MA enters in inverted flight and performs a quarter pirouette. MA then performs three superimposed circles in lateral inverted flight with the rotor disk tilt at least 45 degree from a horizontal plane. After each half funnel except the last the MA performs a half roll. After three funnels (and five half rolls) the MA exits in upright flight. The diameter of the circles should be at least 10 meters.
- 1.29 Pirorainbow X reversal** **K=11.5**
 MA hovers over the centre line with an angle of 45°, then enters the manoeuvre with a rainbow, a not stationary flip that follows an arched flight path of at least 10 meters length. During the rainbow the MA performs one pirouette in each direction, with the reverse on the top of the rainbow. Then another rainbow (with pirouette reversal) leads back to the starting point. MA then continues with these rainbows alternately about the longitudinal and the lateral axis, until the four outer points of an X (viewed from above) are reached and MA hovers where it started the manoeuvre. MA does not perform any part of pirouettes, when hovering in the centre. During the stops at the four outer points, rotor disk must be horizontal but there should be no hovering.

1.30 Pirouetting globe reversal

K=10.0

MA enters in upright flight and then performs four pirouetting loops. During each loop, the flight path is changed continually in a way that the low point is passed rotated about 45° (seen from above) until a complete globe has been described.

After each loop the pirouetting direction is changed. The MA exits the manoeuvre at the same altitude but in opposite direction to the beginning. During each loop, the MA must perform at least two pirouettes.

The manoeuvre drawings appear on the next page.

5F.2 SET MANOEUVRE DRAWINGS

Set Manoeuvres 1 – 17 (of 30)

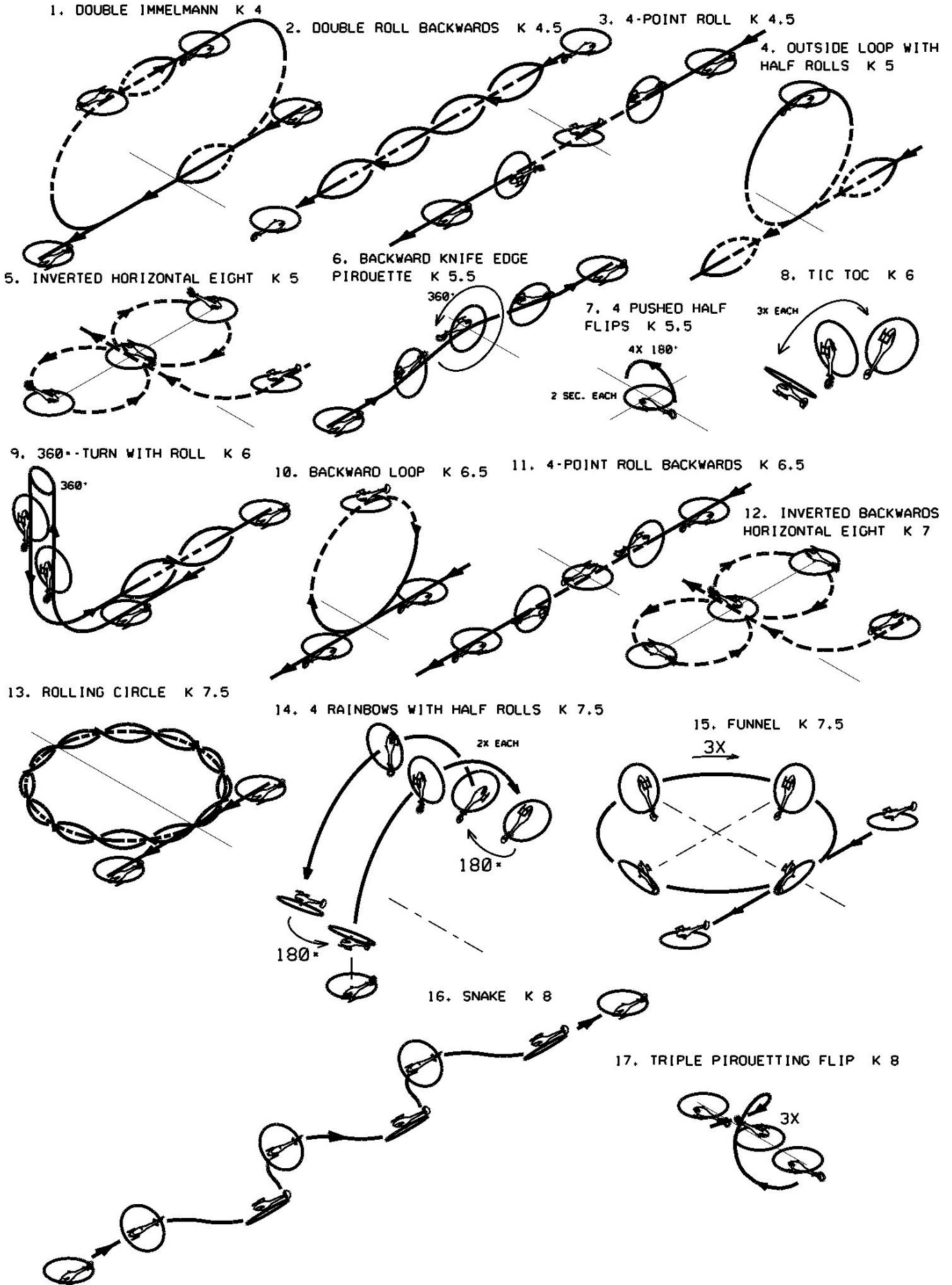

Set Manoeuvres 18 – 30.

18. CUBAN EIGHT BACKWARDS K 8

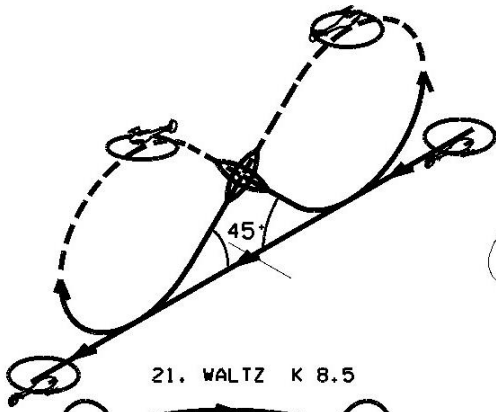

19. PIRQUETTING LOOP K 8

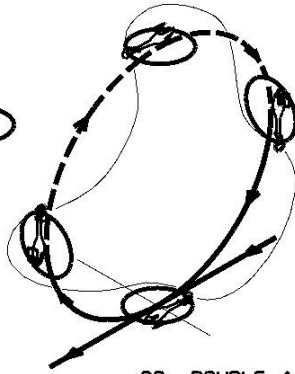

20. BACKWARD ROLLING CIRCLE K 9

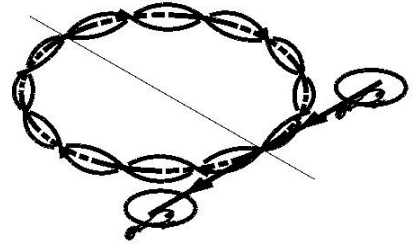

21. WALTZ K 8.5

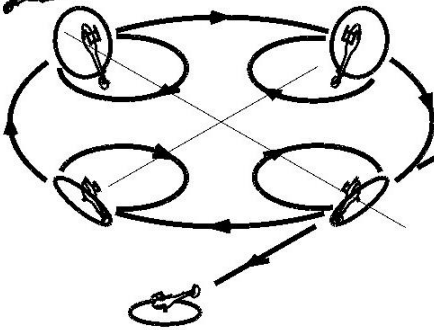

22. DOUBLE 4-POINT TIC TOC K 8

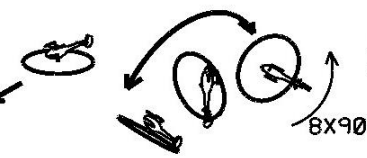

23. PIRQUETTING FUNNEL K 8.5

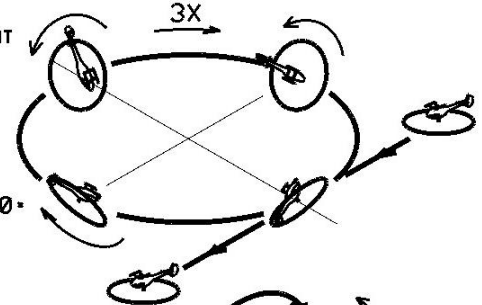

25. PIRQUETTING GLOBE K 9

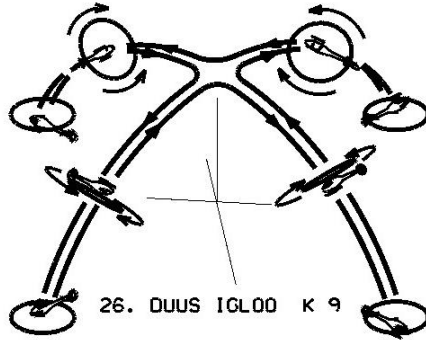
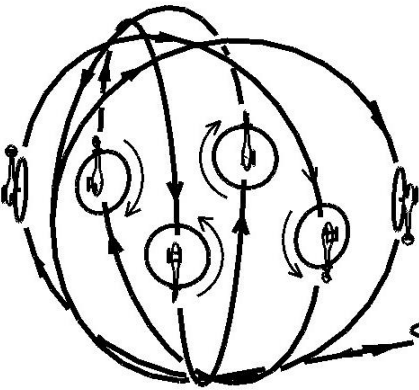

26. DUUS IGLOOD K 9

24. 4-POINT TIC TOC REVERSAL K 9

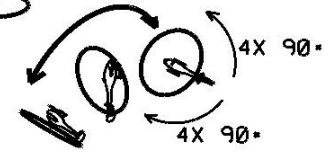

27. ROLLING CIRCLE TAIL REVERSAL K 9.5

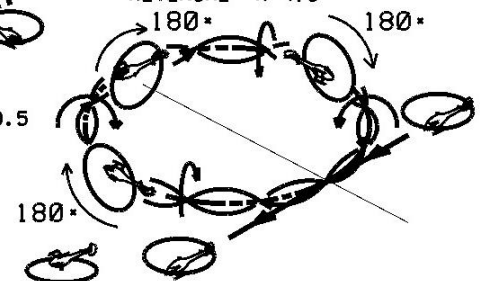

28. FUNNEL WITH HALF ROLLS K 9.5

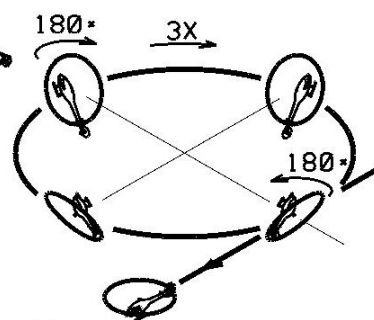

29. RAINBOW X REVERSAL K 11.5

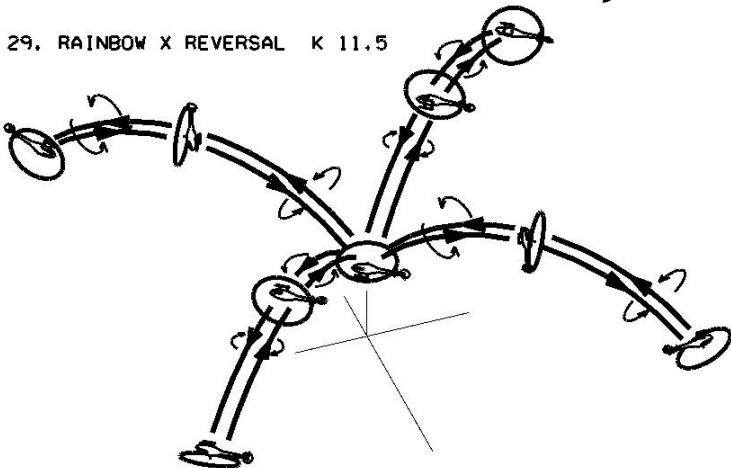

30. PIRQUETTING GLOBE REVERSAL K 10

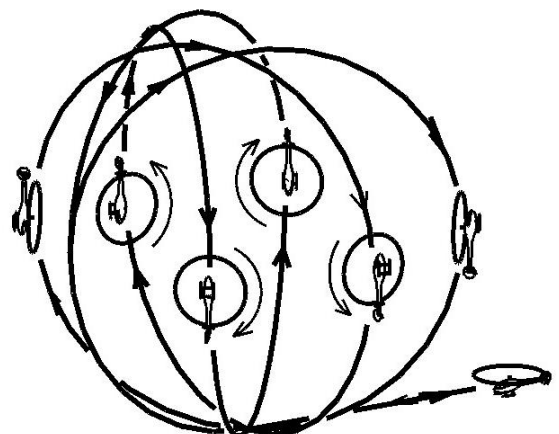

PAGE DELIBERATELY LEFT BLANK

5F.3 CLASS F3N OPTIONAL MANOEUVRE LIST

The Optional Manoeuvre list will be available from the F3 Helicopter Subcommittee Chairman at the beginning of each year.

The optional manoeuvres will be labelled B1 through B10.

Each year the optional manoeuvres will be modified or changed to adapt to the rapidly evolving F3N class. Organisers of F3N competitions must announce the use of a new list if appropriate at least 6 months prior to the event. The following will apply:

- For World or Continental Championships all optional manoeuvres must come from the annual list.
- For National Championships it is recommended that at least 5 manoeuvres should come from this list.
- For local competitions the organiser does not have to use manoeuvres from this list.

Number	Description	K-Factor
B.1	<p>Rolling Globe reversal</p> <p>MA enters in upright flight and then performs four rolling loops. During each loop, the flight path is changed continually in a way that the low point is passed rotated about 45° (seen from above) until a complete globe has been described.</p> <p>After each loop the roll direction is changed. The MA exits the manoeuvre at same altitude as the entry, but in opposite direction. During each loop, the MA must perform exactly 1 roll with constant roll rate.</p>	11.0
B.2	<p>Double O One Twins</p> <p>MA enters in forward upright flight parallel to the flight line. Model performs ¼ of a loop. After the ¼ loop the boom is vertical, and model is on centre line. MA then performs one complete outside loop. During the first half of the loop, the model performs half pirouette, and during the second half of the loop, the model performs another half pirouette in opposite direction. MA is now back to same point on the centreline and with same orientation as when the complete loop started. Model now performs a complete inside loop, with pirouettes similar to the first complete loop. After second complete loop, MA performs ¼ roll, and it then repeats the above sequence with the 2 loops on the centreline. After 4th loop, MA makes ¼ roll and exits via ¼ loop in backward flight to the same side and height as the entry came from. All loops must have same size and pirouettes same constant rate.</p>	11.5
B.3	<p>Piro Globe double reversed</p> <p>MA enters in upright flight and then performs four pirouetting loops. During each loop, the flight path is changed continually in a way that the low point is passed rotated about 45° (seen from above) until a complete globe has been described.</p> <p>After each loop the pirouetting direction is changed at the bottom of the loop. At each top of the loops MA changes orientation from rotor disc outside (inside) to rotor disc inside (outside) while still performing pirouettes. The MA exits the manoeuvre at the same altitude but in opposite direction to the beginning. During each loop, the MA must perform at least two pirouettes.</p>	10.5
B.4	<p>3D Clock</p> <p>MA is hovering nose in on centreline. It then makes half pulled flip to skids in nose up vertical position. It then performs 12 tic tocs. After or during each tic toc, the tail rotates corresponding to 1 hour. Furthermore, the clock is rotating, so that skids are in at 12 o'clock, tail is in at 3 o'clock, rotor disc is in at 6 o'clock, and finally tail is in again at 9 o'clock. Model exits by returning to hover in same position and orientation as at the start of the manoeuvre.</p>	11.5
B.5	<p>Galaxy</p> <p>MA enters in upright flight, performs a quarter pirouette and starts a funnel with the rotor disk tilt 30 degree from a horizontal plane with the tail pointing to the center. During the funnel the radius of the circular flight path decreases and the declination of the rotor disc increases, so the path becomes a spiral. After 720° (2 spiral shaped "circles") the declination should be about 60°. Then a smaller half funnel follows where the declination of the rotor disc becomes vertical when the model crosses the imaginary center point of the funnel spiral.</p> <p>When MA crosses this point it performs a half pirouette and immediately continues with a small half nose down inverted funnel (the flight path has the shape of an S here when viewed from above), followed by two inverted funnels (the nose now pointing to the circle center) with increasing radius (and decreasing declination of the rotor disc) and exits the manoeuvre in inverted flight in the same direction but in a different distance as the entry.</p>	11.0

During the manoeuvre the height of the flight path must be constant.

- B.6 Cuban 8 with roll reversal 10.0**
 MA enters in upright backward flight. When crossing the centre line it starts continuous rolls. While rolling, MA performs half Cuban 8 parallel to the flight line. Symmetrically around the centreline, MA stops rolls, performs half pushed elevator flip, and restarts rolling in opposite direction by changing the aileron input direction. MA is now in forward flight while rolling. MA then performs second half of the Cuban 8 while continuously rolling. Symmetrically around the centreline, MA stops rolls, performs half pushed elevator flip, and restarts rolling in the same direction as was used at the manoeuvre start. MA stops rolling and exits in upright backward flight.
- B.7 Deathspinner 11.0**
 MA hovers tail in, upright and below top of a 60° window. MA then performs a quarter flip and starts falling down backwards vertically. During descending MA performs a ½ roll with at least 2 integrated pirouettes followed by another ½ roll in opposite direction with again at least 2 integrated pirouettes also in opposite direction. After finishing the rolls and pirouettes MA performs a quarter flip and hovers for at least one second inverted.
 The start position has to be exactly above the end position, and the manoeuvre should utilize a significant fraction of the start height.
- B.8 Rough Diamond 10.0**
 MA hovers on centreline with boom parallel to judgeline. It then performs 2 forward 360° tumbles while moving in a 45° up direction. MA makes ¼ right (left) pirouette to tail in orientation. It then performs 2 complete right (left) rolls in a 45° up direction, followed by another ¼ right (left) pirouette. MA is now at top of the diamond on the centreline. MA then performs 2 backward 360° tumbles while moving in a 45° down direction, followed by another ¼ right (left) pirouette to nose in orientation. Finally MA performs 2 complete right (left) rolls while moving in a 45° down direction, followed by a last ¼ right (left) pirouette. MA is now back to starting point and in same orientation. Hovering must only occur at start and exit of the manoeuvre.
- B.9 TicToc smile 10.0**
 MA hovers parallel to the judges line at least 5m aside with the nose pointing to the centerline. MA then performs a quarter roll and immediately starts a half tic-toc loop downwards (the lower lip) with the rotordisc pointing to the judges and the nose always pointing to the center of the circle. When MA passes the centerline, tail boom must point downwards.
 After the half tic-toc loop is completed MA immediately performs a half elevator flip (either direction) to knife edge with the skids now pointing to the judges. MA now moves back to the starting point of the manoeuvre by performing a fraction of a half tic-toc loop (the upper lip) with the tail boom always pointing to the center of the circle. When it now crosses the centerline the nose must point downwards and MA must be clearly higher than in the lower lip.
 When MA returns to the start position it again performs a half elevator flip (either direction) and a quarter roll to upright hovering. MA must now be back in the same position and orientation as at the beginning.
- B.10 Pirouetting Waltz Reversal 11.0**
 MA enters in inverted flight and then starts pirouetting whereas it performs different circles in lateral inverted flight with the rotor disk tilt at least 30 degree from a horizontal plane. After a quarter funnel MA performs a complete smaller pirouetting funnel (max. half diameter of the first) while pirouetting in the opposite direction then continues with another quarter larger pirouetting funnel in the same pirouetting direction as the first quarter, followed again by a complete smaller pirouetting funnel again in the opposite direction etc. After the larger pirouetting funnel is completed there is again a complete smaller pirouetting funnel, followed by the exit in inverted flight. The diameter of the large pirouetting funnel should be at least 20 meters.
 Pirouetting rate must be chosen, so that each ¼ of the large circle includes exactly 1 complete pirouette, and so that each of the small circles also includes exactly 1 pirouette.

The Optional Manoeuvre diagrams appear overleaf.

5F.4 Optional Manoeuvre Drawings

Optional Manoeuvres 1-5 (of 10)



B.1 ROLLING GLOBE REVERSAL

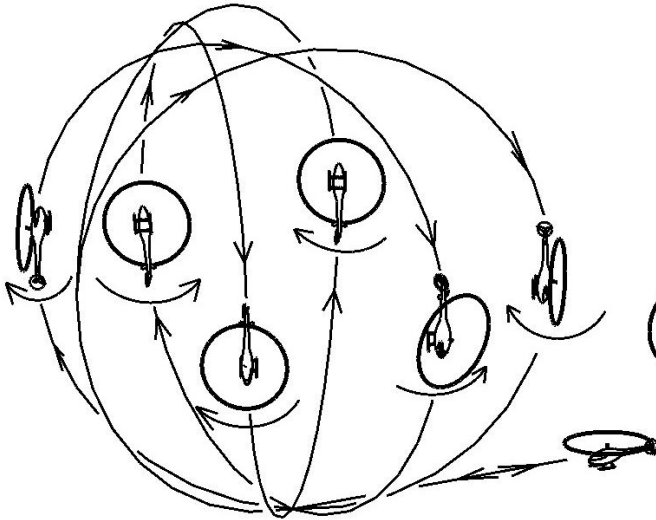

B.2 DOUBLE O ONE TWINS

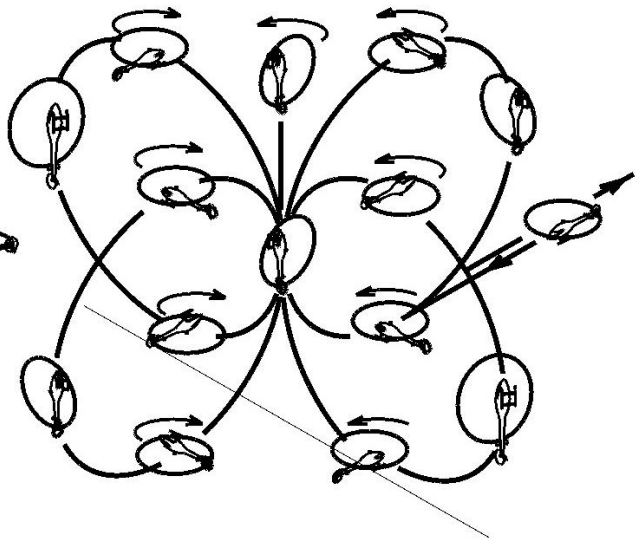

B.3 PIRO GLOBE DOUBLE REVERSED

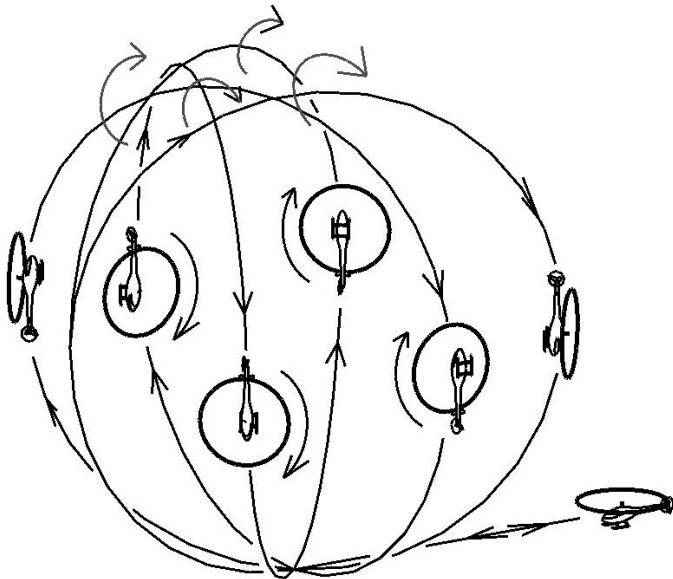

B.4 3D CLOCK

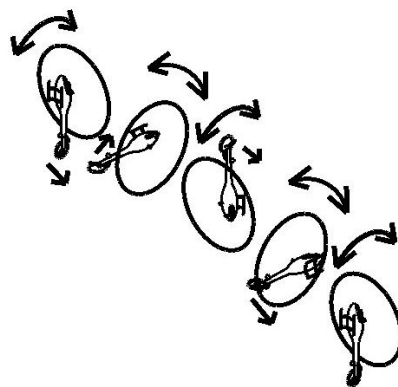

B.5 GALAXY

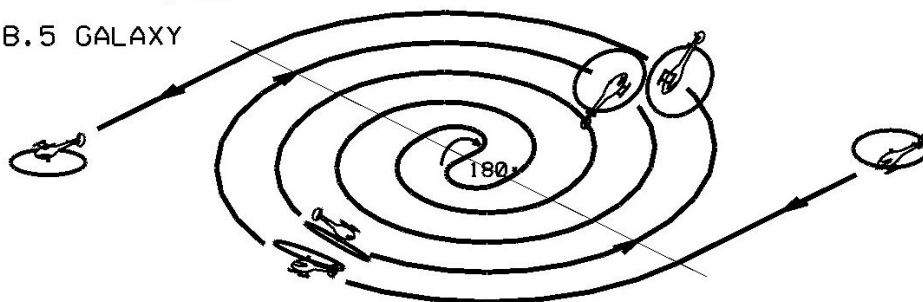

Optional Manoeuvres 6 -10



B.6 CUBAN EIGHT WITH ROLL REVERSAL

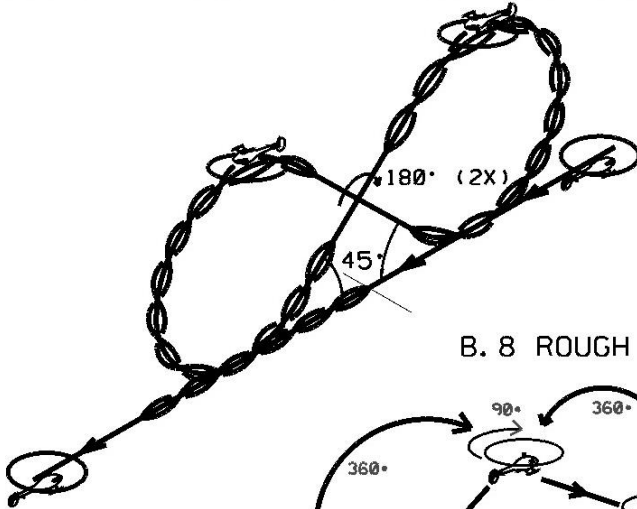

B.7 DEATHSPINNER



B.8 ROUGH DIAMOND

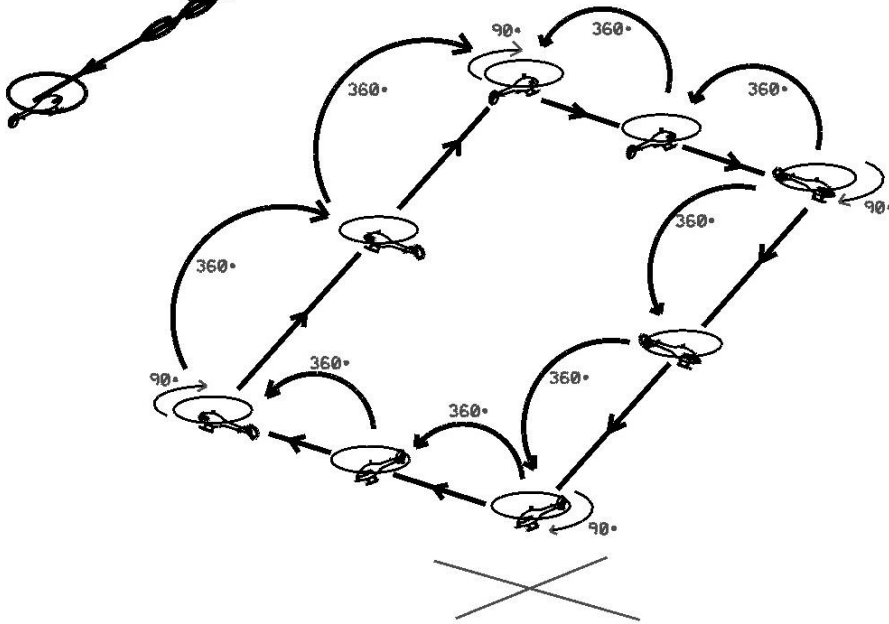

B.9 TIC TOC SMILE

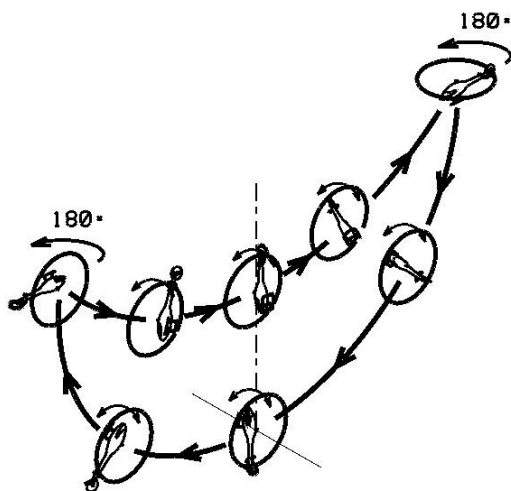

B.10 PIRQUETTING WALTZ REVERSAL

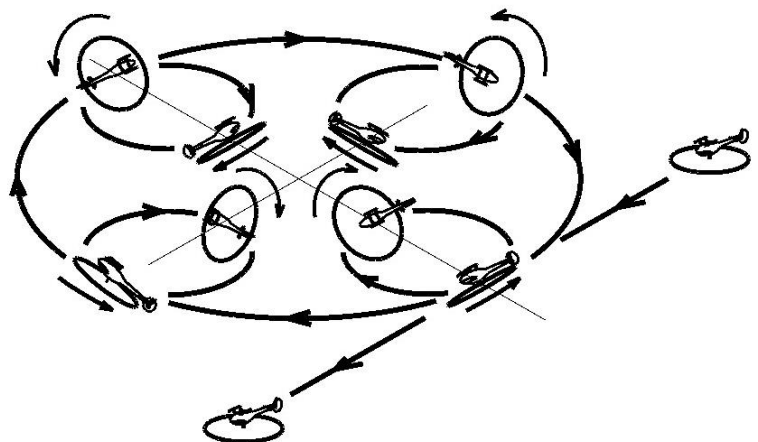

ANNEX 5G

F3N JUDGES GUIDE

5G.1 PURPOSE

The purpose of the F3N judges guide is to provide an accurate description of the major judging criteria to serve as a reference for use in developing a uniformly high standard of judging.

5G.2 PRINCIPLES

The principles of judging a radio controlled model helicopter should be based on the perfection with which the model aircraft performs each set manoeuvre as described in Annex 5F.11.

The main principles used to judge the degree of perfection are:

- 1) Precision of the manoeuvre.
- 2) Smoothness and gracefulness of the manoeuvre.
- 3) Positioning or display of the manoeuvre.
- 4) Size of the manoeuvres relative to each other.

The requirements are listed in order of importance; however, all of them must be met for a manoeuvre to receive a high score or even the maximum of 20 points.

Basically all judging starts with the respective point maximum, from where points are subtracted according to the grading criteria of this guide.

5G.3 ACCURATE AND CONSISTENT JUDGING

The most important aspect of judging is consistency. Each judge must establish his standard and then maintain that standard throughout the competition. It is recommended that the contest director or organiser hold a conference prior to the start of competition to discuss judging so that the standards are as uniform as possible. This should be accomplished with demonstration flights that all judges score simultaneously and privately. After these flights, the defects in each manoeuvre should be discussed by all judges and agreement reached about the severity of the defects. After the competition is started, the individual judges should not alter their standard. Judging accuracy is also very important. Being consistent, whether high or low is not sufficient if the scores awarded do not fairly reflect the performed manoeuvre.

5G.4 CRITERIA FOR JUDGING MANOEUVRES

A description of each set manoeuvre is provided in Annex 5F.11.

Each manoeuvre should be downgraded according to:

- 1) The type of defect.
- 2) The severity of the defect.
- 3) The number of times a defect occurs.
- 4) The positioning of the manoeuvre.
- 5) The size of the manoeuvre relative to other manoeuvres.

A high score should be given only if no major defects are noted and the manoeuvre is accurately positioned. Whenever there is doubt a lower score should be given.

5G.5 ATTITUDE AND FLIGHT PATH

The flight path of the model aircraft (MA) is the trajectory of its centre of gravity. The attitude is the orientation of the rotor disc (RD) in relation to the flight path. All judging should be based on the flight path, but the angle between flight path and RD should not exceed 15° (if not specified otherwise). For higher angles one point per 5° should be subtracted.

5G.6 GRADING CRITERIA FOR MANOEUVRES AND SEGMENTS

The set manoeuvres are composed of segments. The following criteria are furnished to provide the judge with a guide for downgrading deviations from the defined manoeuvre segments.

These segments are: Loop, Roll, horizontal Circle, Turn, Pirouette, Autorotation, Flip, Tic-Toc, Rainbow, Snake and Funnel or parts of them. If a manoeuvre contains several segments of the same type than these have to be similar, e.g. same radii for loops, same roll rates for rolls, same pirouette turning rates etc.

Basically all aerobatic manoeuvres start and end with a straight and level flight of 10 metres minimum length parallel to the judges line (except horizontal eights). All manoeuvres from stationary flight start and end with a hovering of at least 1 second with the model parallel or vertical to the flight line. If one of these segments is missing 2 points should be subtracted.

cont/...

If the orientation of the entire manoeuvre or segments of it is not parallel to the defined line or plane, 1 point per each 5° deviation should be subtracted. If the manoeuvre is not positioned symmetrically to the centreline a downgrade of 1 point per each 5 m should be made.

These two guides (1 point per 5° and 1 point per 5 m) can also be used as a rule of thumb when in doubt and if the downgrades are not defined otherwise.

If the flight altitude changes in horizontal passages a downgrade of 1 point per 2 m for aerobatic and of 1 point per 50 cm for hovering manoeuvres should be made.

In general every severe mistake should also lead to a severe downgrade about 6 points, a medium defect to about 3 points and a small deviation to about one point. Of course the number of mistakes has a big influence too, if a manoeuvre has many severe defects the first one will result in 6 points downgrade, the second one in 4 points, the third in 2 and every further in 1 point. If, in spite of many severe mistakes, the manoeuvre is still recognisable and no parts are missing, the score should not fall below 5 points. If entire segments are missing or the manoeuvre is completely unrecognisable the score must be zero.

5G.6.1 LOOP

A loop must have a constant radius and must be flown in a vertical plane. MA attitude and flight path have to differ to keep the momentum (but less than 15°). The speed of MA should not vary too much and the radius must be smooth and not segmented.

5G.6.2 ROLL

A roll is a rotation about the longitudinal axis of MA. To keep the momentum, for a horizontal roll the longitudinal axis must maintain its angle to a horizontal plane. Start and end of rolls should be crisp and well defined.

5G.6.3 HORIZONTAL CIRCLE

MA speed and circle diameter should be chosen in a way that a circle is flown with less than 20° declination of RD. MA speed and circle diameter have to be constant.

5G.6.4 TURN

A turn is a rotation about the yaw axis after a vertical ascent and just before the complete stop of MA. This rotation must be symmetrical by performing half of it before and the other half after the moment MA comes to a halt. The rotation must be of constant rate without interruptions, with crisp and well defined start and end.

5G.6.5 PIROUETTE

A pirouette is a rotation about the yaw axis. The rotation must be of constant rate without interruptions, with crisp and well defined start and end. Since in F3N pirouettes are not flown stationary but only combined with other manoeuvre segments (like loops, flips and funnels) it is important, that the pirouette does not affect the flight path.

5G.6.6 AUTOROTATION

During this manoeuvre the model should follow an almost straight flight path from the start to the landing on the helipad. This path may be interrupted by a flip or roll but should be resumed after this. If the landing point is not in the circle, a downgrade of 1 point per 1 m distance should be made.

5G.6.7 FLIP

A flip is a rotation about an axis normal to the rotor shaft. Stationary flips need to have a small altitude oscillation (low with RD horizontal, high with RD vertical) which should be less than 50 cm. Lateral deviations of these flips should be downgraded by 1 point per 50 cm.

Travelling flips should not affect the described flight path.

A pushed flip is done by performing the elevator impulse at the transmitter in forward direction. A pulled flip is done by performing the elevator impulse at the transmitter in backward direction.

5G.6.8 TIC-TOC

MA hovers or moves slowly and is rotated using cyclic pitch about 135°. It then rotates its RD in a 90° arc back and forth. A movement of the centre of gravity of less than 2 m for simple tic-tocs or less than 5 m for tic-tocs with pirouettes should not lead to a downgrade, for greater deviations 1 point should be subtracted for the mentioned distances.

5G.6.9 RAINBOW

A rainbow is a semicircle, starting from hovering, with RD always normal to the flight path. The diameter of the semicircle should not be less than 10 m. The start and stop shall be crisp and well defined.

cont/...

5G.6.10 SNAKE

While in fast flight MA follows a wavy line by alternately performing upright and inverted quarter circular segments of equal diameter and length.

During these circular segments the banking must not fall below 45°. A banking of less than 20° means just an array of quarter circles but not a snake and makes the manoeuvre unrecognisable, ie zero points.

5G.6.11 FUNNEL

A funnel is a circle with at least 10 m diameter, performed with a declination of RD of at least 45° from a horizontal plane. MA speed, declination and circle diameter should be constant. A declination of less than 20° means just a horizontal circle but not a funnel and makes the manoeuvre unrecognisable, ie zero points.

5G.6.12 REVERSAL

Cyclic or pirouette reversals must be performed in a way, that the number of rotations in each direction is almost equal. A relation of e.g. 2:1 should lead to a downgrade of 4 points.

If not defined otherwise, the direction of rotation should alter after every 360° rotation.

5G.7 WIND CORRECTION

All manoeuvres are required to be wind corrected in such a way that the shape of the manoeuvre as described in Annex 5F.11 is preserved in the model aircraft's flight path.

To countervail lateral wind (in horizontal or vertical passages) MA must turn its longitudinal axis against the wind. This attitude must not lead to a downgrade as long as the flight path is correct.

Wind parallel to the flight line must be compensated with pitch in vertical passages, an angle between flight path and attitude will in that case lead to a downgrade of 1 point per 5°.

5G.8 CRITERIA FOR JUDGING FREESTYLE FLIGHT AND MUSIC FREESTYLE

For freestyle and music freestyle flights the entire flights will be judged according to the table below:

Criterion	Max Points Freestyle	Max Points Music Freestyle
Difficulty	20 k=3	20 k=2
Harmony	20 k=1	20 k=2.5
Creativity	20 k=1	20 k=2.5
Precision	20 k=3	20 k=2
Safe presentation	20 k=1	20 k=1

For freestyle and music freestyle flights the judges can give maximum 20 points to all criteria. The valence of each criterion is regulated by k-factors.

The scores are given after the flight for all five criteria. It is important, that the scores for each criterion reflect the entire flight, not only some details of the flight.

5G.8.1 DIFFICULTY

This criterion evaluates the level of difficulty of the freestyle flight and music freestyle flight. It is important, that the entire flight is to be judged, not only some highlights. So the score reflects the average level of difficulty. The K-factors of the set manoeuvres may give some reference values for the difficulty, but during the calibration flights and by watching practice flights the judge should get a clear impression of the range of difficulties of possible manoeuvres. Risky manoeuvres should never be mistaken as difficult manoeuvres. Risky manoeuvres must not lead to higher scores for difficulty, but result in a downgrade for safety.

5G.8.2 HARMONY

The combination of the manoeuvres, smooth or flowing transitions between them are the main factors for this criterion. Also the manoeuvres size and dynamic in relation to the model aircrafts performance is of influence. The pace is not of influence here, harmony can be as well demonstrated in dynamic as in gentle sequences.

In Music flights also the harmony between the music and the presentation comes to influence here.

5G.8.3 CREATIVITY

New combinations or new manoeuvres at all will lead to high scores here. Also dynamic and diversified sequences are positive.

There also should be a variety of different tempi in the presentation. Sequences without manoeuvres or repetitions will lead to downgrades.

In Music flights the transformation of musical accents into the performance is of great importance here.

5G.8.4 PRECISION

Precision and recognition of manoeuvres and sequences are evaluated here. The criteria cannot be as strict as for the set manoeuvres as they have to meet an entire flight, but the principles stay the same.

5G.8.5 SAFE PRESENTATION

In addition to the safety rules during the flight(s) (5F.10), the impression of the presentation related to safety is the guide here. If a pilot does not exceed the limit of his skills or flies unsafe in any way (eg too close to himself) a high score can be given here. Flying low (within the rules) by itself is not a reason for downgrade.

5G.8.6 EVALUATION OF THE LEVEL OF DIFFICULTY FOR FREESTYLE SCHEDULE

The following table gives reference values for the estimation of the level of difficulty for both schedules, unlimited and music freestyle.

Aerobic Manoeuvres in Basic Orientations	
10	Examples: Immelmann, short straight passages, loop, loop with full pirouette on top, roll, turn, 540° turn, pirouettes
15	Examples: ½ Cuban eight, long passages, nose-in circle, flips, autorotation
20	Examples: inverted hovering on eyelevel, flip sideward, Cuban eight, flips with hovering stops
20-30	Examples: Horizontal eight, loop sideways, turn with hesitations and/or changes of turning direction, rolling stall turn, autorotation with 180 degree turn, death spiral, knife edge pirouette, speed circle, stationary tictoc, funnel, 4-point roll, multi-point tictoc, Snake
Aerobic Manoeuvres in Several Orientations	
30-45	Aerobic manoeuvres that demonstrate several orientations like inverted, sideways, backwards etc. Examples: Backward Inverted Cuban eight, skids in and out knife edge manoeuvres, snake parallel to flight line and to centerline, different kinds of funnels like waltz
Aerobic Manoeuvres including Piros, Rolls and Flips Etc	
40-55	Aerobic manoeuvres flown in a way where in addition to the CG movement of the main manoeuvre, the model is continuously performing rolls, piros, flips, tictocs or similar. In order to get a high score, many orientations must be shown. Examples: Pirouetting Globe, Chaos, Rolling Globe, Rolling circles, Pirouetting funnels
Aerobic Manoeuvres including Reversals and Transformations	
50-60	Aerobic manoeuvres flown in a way, where piros, rolls, tictocs or other secondary manoeuvres are included/integrated and reversed in an equal and balanced way. Examples: Rolling globe with roll reversals, horizontal circle with continues flips/rolls so that tail boom is always parallel to centerline, Reversing chaos In order to score near maximum, many orientation changes must be displayed, and flight must include many clearly defined manoeuvres.

ANNEX 5H RADIO CONTROL MODEL HELICOPTERS WORLD CUP RULES

5H.1. Class

The F3C and F3N class are recognised for World Cup competition (Radio Control Model Helicopters).

5H.2. Competitors

All competitors in the specified open international contests are eligible for the World Cup.

5H.3. Contests

Contests included in the World Cup must appear on the FAI Contest Calendar, and must be run according to the FAI Sporting Code. The contests eligible for a World Cup in a particular year, must be nominated before the CIAM Bureau Meeting at the end of the preceding year, and must be included in the FAI Contest Calendar. The selection of the contests should be according to the following guidelines:

- a) a maximum of two contests may be selected for any one country.
- b) each competitor may count only one competition from each country in Europe (taking the better score for any European country in which he has scored in two competitions).
- c) at least three (3) judges have to be appointed for each judges' panel.

5H.4. Points allocation

The points to be allocated to competitors will depend on the number (N) of competitors who have completed at least one flight in the event. A competitor has completed a flight if he registers a score greater than zero (0).

Points are allocated to competitors who have completed at least one flight in the event, according to their placing in the results, as given in the following tables:

a) $N \geq 15$

Placing	1	2	3	4	5	6	...	15	15 and after
Points	15	14	13	12	11	10	...	1	0

A bonus of 6 points is given to the first placed competitor; 4 points to the second placed and 2 points to the third placed.

b) $N < 15$

Placing	1	2	3	4	5	6	...	N
Points	N	N-1	N-2	N-3	N-4	N-5	...	1

A bonus of 3 points is given to the first placed competitor; 2 points to the second placed and 1 points to the third placed.

5H.5. Classification

The World Cup results are determined by considering the total of points obtained by each competitor in the World Cup events. Up to three events may be counted, selecting each competitor's best scores during the year. The winner of the World Cup is the competitor with the greatest total.

In the event of a tie for first, second, and third place, the place will be determined according to the following criteria:

The number of events counted is increased, one at a time, from three until the winner is obtained. If this does not separate the tied competitors, then the winner will be determined by considering the points obtained in the best three events multiplied by the number of competitors who have completed at least one flight in the event. The winner is the one with the greatest total thus calculated.

5H.6. Awards

The winner is awarded the title of winner of the World Cup. Certificates, medals and trophies may be awarded by the CIAM F3 Helicopter sub-committee if available.

5H.7. Organisation

The F3 Helicopter sub-committee shall be responsible for organising the World Cup, and may nominate a responsible person or special sub-committee to collate the results.

5H.8. Communication

The F3 Helicopter's sub-committee nominated World Cup coordinator must receive the results from each contest in the World Cup, and then calculate and publish the World Cup positions.

These should be distributed to the news agencies and should also be available to any interested bodies or individuals. Final results of the World Cup must be sent to the FAI, National Airsports Controls, and the modelling press.

5H.9. Responsibilities of competition organisers

Competition organisers must propose their event for inclusion in the World Cup, when nominating events for the FAI international Sporting Calendar. The final selection of events from these proposals is made by the CIAM Bureau as defined in paragraph 3. Immediately after the event, the competition organiser must send the results to the World Cup coordinator, within one month as required in the Sporting code B.2.5. Any failure to return scores promptly will be reviewed by the CIAM Bureau when considering the competition calendar for the following year.

5H.10. World Cup Board

A Board of three persons shall be nominated by the CIAM Helicopter Subcommittee Chairman to rule on any issue concerning the implementation of World Cup rules during a year. Any such issue must be submitted in writing to the Helicopter Subcommittee Chairman. The World Cup Board is not entitled to deal with any kind of complaint or protest concerning a single competition, which must be considered by the FAI Jury for that competition.

---oOo---